User's Guide

EMI Receiver Series

HP 8542E/HP 8546A
EMI Receiver

HP 85422E/HP 85462A
Receiver RF Section



HP Part No. 5962-5081
Printed in USA August 1994

Notice

The information contained in this document is subject to change without notice.

Hewlett-Packard makes no warranty of any kind with regard to this material, including but not limited to, the implied warranties of merchantability and fitness for a particular purpose. Hewlett-Packard shall not be liable for errors contained herein or for incidental or consequential damages in connection with the furnishing, performance, or use of this material.

© Copyright Hewlett-Packard Company 1994
All Rights Reserved. Reproduction, adaptation, or translation without prior written permission is prohibited, except as allowed under the copyright laws.
1400 Fountaingrove Parkway, Santa Rosa CA, 95403-1799, USA



From: Jim Bunker
 Avalon
 760-536-0191
 (2) Duplexes

AAH!
 Dean

847-717-6121

Accessories Supplied

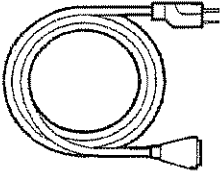
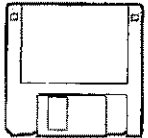
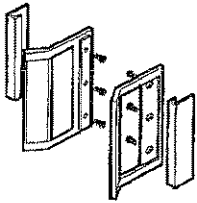
Table 1-1. EMI Receiver Accessories Supplied

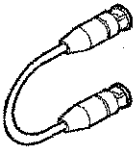
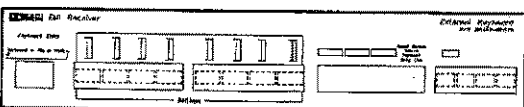
Accessory	Description	HP Part Number
Receiver RF Section		
 accpwr	Power cable	See Table 1-3
 accdisk	Limit line and antenna factor library disk	5010-7721
 acchand	Handles	5062-3991
 accincan	Adapters, Type N (m) to BNC (f)	1250-0780
 accshort	Cable, BNC (m) to BNC (m), 30 cm (12 in) ¹	8120-1838
 smriplate	External Keyboard Template	85462-80010

¹ For a standalone receiver RF section only, 23 cm (9 in), HP Part Number 8120-2682.

1-2 Preparing for Use

Pg 1 of 3

Table 1-1. EMI Receiver Accessories Supplied (continued)

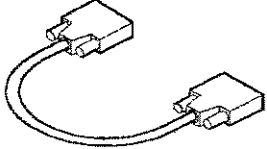
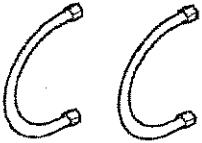
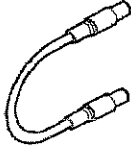
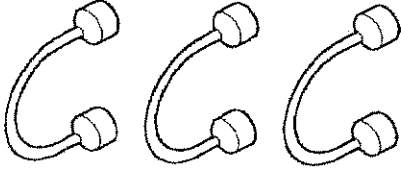
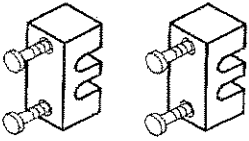
Accessory	Description	HP Part Number
<p>RF Filter Section</p>  <p>acc9pin</p>	<p>Auxiliary interface cable</p>	<p>8120-6337</p>
 <p>accnrigid</p>	<p>Two sweep flexible cables</p>	<p>8120-8154</p>
 <p>accalc</p>	<p>ALC cable</p>	<p>8120-6212</p>
 <p>acc2ypen</p>	<p>Three type-N semi-rigid cables</p>	<p>85460-20036</p>
 <p>accclmp</p>	<p>Two securing spacers</p>	<p>85460-60028</p>

Pg 2 of 3

Certification

Hewlett-Packard Company certifies that this product met its published specifications at the time of shipment from the factory. Hewlett-Packard further certifies that its calibration measurements are traceable to the United States National Institute of Standards and Technology, to the extent allowed by the Institute's calibration facility, and to the calibration facilities of other International Standards Organization members.

Regulatory Information

Regulatory information is located in the *EMI Receiver Series Reference* manual at the end of Chapter 1, "Specifications and Characteristics."

Warranty

This Hewlett-Packard instrument product is warranted against defects in material and workmanship for a period of one year from date of shipment. During the warranty period, Hewlett-Packard Company will, at its option, either repair or replace products which prove to be defective.

For warranty service or repair, this product must be returned to a service facility designated by Hewlett-Packard. Buyer shall prepay shipping charges to Hewlett-Packard and Hewlett-Packard shall pay shipping charges to return the product to Buyer. However, Buyer shall pay all shipping charges, duties, and taxes for products returned to Hewlett-Packard from another country.

Hewlett-Packard warrants that its software and firmware designated by Hewlett-Packard for use with an instrument will execute its programming instructions when properly installed on that instrument. Hewlett-Packard does not warrant that the operation of the instrument, or software, or firmware will be uninterrupted or error-free.

LIMITATION OF WARRANTY

The foregoing warranty shall not apply to defects resulting from improper or inadequate maintenance by Buyer, Buyer-supplied software or interfacing, unauthorized modification or misuse, operation outside of the environmental specifications for the product, or improper site preparation or maintenance.

NO OTHER WARRANTY IS EXPRESSED OR IMPLIED. HEWLETT-PACKARD SPECIFICALLY DISCLAIMS THE IMPLIED WARRANTIES OF MERCHANTABILITY AND FITNESS FOR A PARTICULAR PURPOSE.

EXCLUSIVE REMEDIES

THE REMEDIES PROVIDED HEREIN ARE BUYER'S SOLE AND EXCLUSIVE REMEDIES. HEWLETT-PACKARD SHALL NOT BE LIABLE FOR ANY DIRECT, INDIRECT, SPECIAL, INCIDENTAL, OR CONSEQUENTIAL DAMAGES, WHETHER BASED ON CONTRACT, TORT, OR ANY OTHER LEGAL THEORY.

Assistance

Product maintenance agreements and other customer assistance agreements are available for Hewlett-Packard products. For any assistance, contact your nearest Hewlett-Packard Sales and Service Office.

Compliance

This instrument has been designed and tested in accordance with IEC Publication 348, Safety Requirements for Electronic Measuring Apparatus, and has been supplied in a safe condition. The instruction documentation contains information and warnings which must be followed by the user to ensure safe operation and to maintain the instrument in a safe condition.

Safety Notes

The following safety notes are used throughout this manual. Familiarize yourself with each of the notes and its meaning before operating this instrument.

WARNING

Warning denotes a hazard. It calls attention to a procedure which, if not correctly performed or adhered to, could result in injury or loss of life. Do *not* proceed beyond a warning note until the indicated conditions are fully understood and met.

CAUTION

Caution denotes a hazard. It calls attention to a procedure that, if not correctly performed or adhered to, would result in damage to or destruction of the instrument. Do *not* proceed beyond a caution sign until the indicated conditions are fully understood and met.

General Safety Considerations

WARNING

- No operator serviceable parts inside. Refer servicing to qualified personnel. To prevent electrical shock, do not remove covers.
- If this instrument is not used as specified, the protection provided by the equipment may be impaired. This instrument must be used in a normal condition (in which all means for protection are intact) only.
- For continued protection against fire hazard, replace line fuse only with same type and rating ([F 5A/250V]). The use of other fuses or material is prohibited.

CAUTION

- Before switching on this instrument, make sure that the line voltage selector switch is set to the voltage of the power supply and the correct fuse is installed.
- Always use the three-prong ac power cord supplied with this instrument. Failure to ensure adequate earth grounding by not using this cord may cause instrument damage.
- Only clean the instrument cabinet using a damp cloth.x



The instruction documentation symbol. The product is marked with this symbol when it is necessary for the user to refer to the instructions in the documentation.

CE

The CE mark is a registered trademark of the European Community. (If accompanied by a year, it is when the design was proven.)

ISM1-A

This is a symbol of an Industrial Scientific and Medical Group 1 Class A product.

CSA

The CSA mark is a registered trademark of the Canadian Standards Association.

Manual Conventions

Front-Panel Key

This represents a key physically located on the instrument.

Softkey

This indicates a "softkey," a key whose label is determined by the firmware of the instrument.

Screen Text

This indicates text displayed on the instrument's screen.

EMI Receiver Series Documentation Description

The following documents are provided with either the HP 8542E/HP 8546A EMI receiver or the HP 85422E/HP 85462A receiver RF section.

- *Installation and Verification* provides information for installing your instrument, verifying instrument operation, and customer support.
- *User's Guide* describes instrument features and how to make measurements with your EMI receiver or receiver RF section.
- *Reference* provides specifications and characteristics, menu maps, error messages, and key descriptions.
- *Programmer's Guide* provides information on remote control instrument configuration, creating programs, and parameters for each of the programming commands available.

Contents

1. Getting Started	
What You'll Learn in This Chapter	1-1
Introducing the EMI Receiver	1-1
Getting Acquainted with the EMI Receiver	1-3
Front-Panel Features	1-3
Data Controls	1-6
Number/Units Keypad	1-6
Knob	1-6
Step Keys	1-7
HOLD Key	1-7
Rear-Panel Features	1-7
Screen Annotation	1-10
Receiver RF Section Annotation	1-11
Menu and Softkey Overview	1-12
Disk Drive	1-13
Receiver RF Section Battery Information	1-14
2. Calibration	
What You'll Learn in this Chapter	2-1
Improving Accuracy	2-1
When is Self-Calibration Needed?	2-2
Warm-Up Time	2-2
Calibrating the EMI Receiver	2-3
Using CAL FETCH	2-3
Verifying the Receiver's Calibration	2-3
Using CAL ALL	2-4
Using CAL STORE	2-5
Interrupting calibration	2-5
Using the AutoCal Function	2-6
Setting the Receiver's Clock	2-6
Setting AutoCal Time	2-6
Performing a Partial Calibration	2-7
Performing the Tracking Generator Self-Calibration Routine	2-8
Performing the YIG-Tuned Filter Self-Calibration Routine	2-8
Calibrating the Receiver RF Section as a Standalone Instrument	2-9

3. Making Compliance Measurements	
What You'll Learn in This Chapter	3-1
Introducing the SETUP, TEST, and OUTPUT Keys	3-2
Setting Up a Measurement Using the SETUP Key	3-2
Using Standard Configurations	3-2
Customizing the Standard Configurations	3-3
Modifying Start and Stop Frequencies	3-3
Modifying Reference Level and Input Attenuation	3-3
Modifying IF and Averaging Bandwidths	3-4
Selecting the Active Detector	3-4
Selecting the Measured Detectors	3-5
Measuring Detector Dwell Times	3-6
Controlling the Preamplifier	3-6
Controlling Autoranging	3-7
Loading User-Defined Configurations from a Disk	3-8
Using Limit Lines	3-8
Loading a Limit Line from the Disk	3-9
Using Amplitude Correction Factors	3-10
Loading an Amplitude Correction Factor File from a Disk	3-11
Activating the Windows Display Format	3-12
Making a Measurement	3-14
Tuning the Receiver	3-14
Using the Marker to Tune the Receiver	3-15
Using the Measure at Marker Function	3-16
Creating a Report	3-19
Configuring a Printer	3-19
Configuring and Generating a Report	3-20
4. List-Based Measurements	
Adding Signals to the List	4-3
Viewing the Signal List	4-5
Sorting the Signal List	4-6
Deleting Signals From the List	4-7
Marking Signals	4-8
Remeasuring Signals	4-9
Saving Signal Lists	4-10
Recalling Signal Lists	4-10
Graphing Signal Lists	4-11
Saving Signal Lists Graphs	4-12
5. Stepped Measurements	
Performing a Stepped Measurement	5-1
Selecting a Detector and Setting a Dwell Time	5-3
Using the Marker	5-4
Adding Data to the Signal List Table	5-5
Changing the Frequency Step	5-5
Restarting and Stopping the Measurement	5-5
Using Logarithmic and Linear Steps	5-7

6. Making EMI Diagnostic Measurements	
What You'll Learn in This Chapter	6-1
Resolving Signals of Equal Amplitude	6-2
Resolving Small Signals Hidden by Large Signals	6-5
Increasing the Frequency Readout Resolution	6-8
Decreasing the Frequency Span	6-10
Peaking Signal Amplitude with Preselector Peak	6-11
Tracking Unstable Signals	6-13
Using the Marker Track Function	6-13
Using Maximum-Hold and Minimum-Hold	6-15
Comparing Signals Using Delta Markers	6-18
Measuring Differences Between Two Signals	6-18
Measuring Differences Between Signals On Screen and Off Screen	6-19
Measuring Low-Level Signals	6-22
Reducing Input Attenuation	6-22
Reducing IF Bandwidth	6-25
Reducing Averaging Bandwidth	6-26
Using Video Averaging	6-27
Testing for Distortion Using the Linearity Check	6-30
Measuring Small Signals in the Presence of a Large Ambient Signal	6-30
Using Linearity Check	6-33
Demodulating and Listening to an AM or FM Signal	6-36
7. Making Other Measurements	
What You'll Learn in This Chapter	7-1
Stimulus-Response Measurements	7-2
What Are Stimulus-Response Measurements?	7-2
Using the Receiver With the Internal Tracking Generator	7-2
Stepping Through the Measurement	7-3
Tracking Generator Unleveled Condition	7-7
Measuring Amplitude Modulation with the Fast Fourier Transform Function	7-8
Measuring the Sidebands on a Signal	7-8
Repeating the test	7-12
Measuring 3 dB and 6 dB Bandwidth	7-13
Measuring 99% Power Bandwidth	7-14
Measuring Percent AM Modulation	7-15
Measuring Amplitude and Frequency Difference	7-16
Making 3rd Order Measurements	7-18
8. Limit Lines	
Using Receiver Limit Lines	8-2
Creating, Editing, or Viewing a Limit Line	8-2
Editing an Existing Limit Line	8-6
Defining a Limit Margin	8-7
Activating Limit-Line Testing	8-8
Saving or Recalling Limit-Line Tables	8-8
Saving a Limit-Line Table	8-8
Recalling a Limit-Line Table	8-9
Viewing the Disk Catalog	8-10
Using Signal Analyzer Limit Lines	8-11
Creating, Editing or Viewing a Limit Line	8-11

Selecting Limit-Line Parameters	8-12
Selecting the Amplitude Scale	8-13
Selecting the Limit-Line Table Format	8-15
Activating Limit-Line Testing	8-16
9. Amplitude Correction Functions	
Creating, Editing, or Viewing the Amplitude-Correction Tables	9-1
Activating Amplitude Correction	9-6
Saving or Recalling	9-7
10. Windows	
Learn About the Windows Display	10-1
11. Saving, Recalling, and Outputting Data	
Using a Floppy Disk	11-1
Formatting the Disk	11-1
Filenames	11-2
DOS Filenames	11-2
LIF Filenames	11-2
Available Operations	11-2
Entering a Prefix	11-3
Saving a Trace	11-4
Recalling a Trace	11-6
Saving and Recalling Data from Internal Memory	11-9
Saving a State	11-9
Recalling a State	11-9
Saving a Trace	11-10
Recalling a Trace	11-10
Protecting Data from Being Overwritten	11-11
How to Output Data	11-12
Configuring a Printer	11-12
Configuring and Generating a Report	11-13
12. Additional Features	
What You'll Learn in This Chapter	12-1
Signal Analyzer Emulation	12-1
Demodulator	12-2
Tracking Generator	12-2
User-Definable Softkeys	12-5
Defaults	12-5
Programming	12-6
Resetting	12-6
External Keyboard	12-7
Installation	12-7
Using the Template	12-8
Entering Data Using the External Keyboard	12-9
Entering Annotation	12-9
Entering Programming Commands	12-10
Entering a Screen Title	12-10
Entering a Prefix	12-11

13. Error Messages	
Nonrecoverable System Errors	13-14
14. Customer Support	
If You Have a Problem	14-1
Calling HP Sales and Service Offices	14-1
Check the Basics	14-2
If Your EMI Receiver Does Not Turn On	14-2
If the RF Filter Section Does Not Seem to be Working	14-2
If the EMI Receiver Cannot Communicate Via HP-IB	14-2
Verification of Proper Operation	14-2
If the RF filter section Does Not Power Off	14-2
Error Messages	14-2
Additional Support Services	14-3
CompuServe	14-3
FAX Support Line	14-4
Returning the EMI Receiver for Service	14-5
Package the EMI receiver for shipment	14-5

Index

Figures

1-1. EMI Receiver	1-1
1-2. Front-Panel Feature Overview	1-3
1-3. Rear-Panel Feature Overview	1-7
1-4. EMC Screen Annotation, Normal Operating Mode	1-10
1-5. EMC Screen Annotation Using Windows	1-11
1-6. Rear-Panel Battery Information Label	1-14
3-1. Active Detector and Measured Detector Messages	3-5
3-2. "PREAMP ON" and "AUTORANGE ON" Messages	3-7
3-3. Using the Measure at Marker Function	3-17
6-1. Set-Up for Obtaining Two Signals	6-3
6-2. Resolving Signals of Equal Amplitude	6-4
6-3. IF Bandwidth for Resolving Small Signals	6-5
6-4. Signal Resolution with a 30 kHz IF Bandwidth	6-6
6-5. Signal Resolution with a 10 kHz IF Bandwidth	6-7
6-6. Using the Marker Counter	6-9
6-7. After Zooming In on the Signal	6-10
6-8. Peaking Signal Amplitude Using Preselector Peak	6-12
6-9. Using Marker Tracking to Track an Unstable Signal	6-14
6-10. Viewing an Unstable Signal Using Max Hold A	6-16
6-11. Viewing an Unstable Signal using Max and Min Hold	6-17
6-12. Placing a Marker on the CAL OUT Signal	6-18
6-13. Using the Marker Delta Function	6-19
6-14. Frequency and Amplitude Differences	6-20
6-15. Using the Delta Meas Function	6-21
6-16. Low-Level Signal	6-23
6-17. Using 0 dB Attenuation	6-24
6-18. Decreasing IF bandwidth	6-25
6-19. Decreasing Averaging Bandwidth	6-27
6-20. Using the Video Averaging Function	6-29
6-21. Set-Up for Obtaining Two Signals	6-31
6-22. Using Linearity Check to Detect Compression	6-32
6-23. Set-Up for Obtaining Two Signals	6-33
6-24. Generating Third Order Distortion Products	6-34
6-25. Using Linearity Check to Identify Distortion Products	6-35
7-1. Receiver/Tracking Generator System Block Diagram	7-2
7-2. Transmission Measurement Test Setup	7-3
7-3. Tracking-Generator Output Power Activated	7-4
7-4. Normalized Trace	7-6
7-5. Maximum Modulation Frequency versus Sweep Time	7-10
7-6. Using the FFT Function	7-11
7-7. Using the 6 dB Points Function	7-13
7-8. Using the 99% Pwr BW Function	7-14
7-9. Using the % AM Function	7-15
7-10. Using the Delta Meas Function	7-16
7-11. Using the Pk-Pk Function	7-17
7-12. Setup for Making 3rd Order Measurements	7-18

7-13. Using 3rd Ord Meas Function	7-19
12-1. External Keyboard Template	12-8

Tables

3-1. HP 8542E/HP 8546A Standard Configurations	3-2
11-1. Internal Memory and Floppy Disk Operations	11-3
11-2. Save Functions Using a Floppy Disk	11-7
11-3. Recall Functions Using a Floppy Disk	11-8
11-4. Summary of Save and Recall Operations, Internal Memory	11-11
14-1. Hewlett-Packard Sales and Service Offices	14-6

Getting Started

What You'll Learn in This Chapter

This chapter introduces the EMI Receiver, HP 8542E and HP 8546A, and describes their basic functions. In this chapter you will:

- Get acquainted with the front-panel and rear-panel features.
- Learn about screen annotation.
- Get acquainted with the menus and softkeys.
- Learn about the disk drive.
- Learn about the receiver battery.

Note

For complete configuration and installation information, refer to the *EMI Receiver Series Installation and Verification Manual*.

Introducing the EMI Receiver

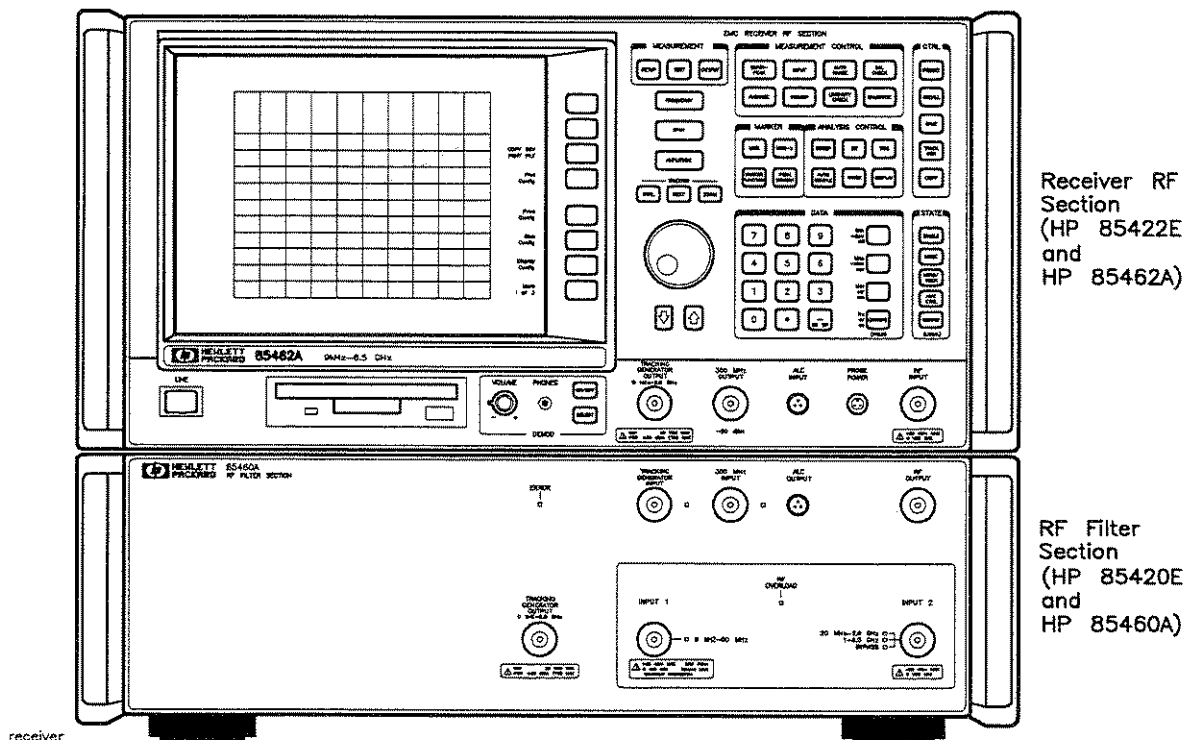

Figure 1-1. EMI Receiver

The EMI Receiver Series is a high-performance test receiver especially designed for making commercial EMI (Electro-Magnetic Interference) measurements. It fully conforms to the receiver standards described in CISPR (Comité International Spécial Des Perturbations Radioélectriques) Publication 16, *C.I.S.P.R. Specification for Radio Interference Measuring Apparatus and Measurement Methods*. This type of receiver is used for making measurements according to various governmental standards, such as FCC (U.S.A.), EN (Europe), and VCCI (Japan) regulations. The HP 8542E/HP 8546A tunes from 9 kHz to 6.5 GHz (9 kHz to 2.9 GHz for the HP 8542E), making it suitable for testing a wide variety of products ranging from ITE (Information Technology Equipment) and ISM (Industrial, Scientific, and Medical Equipment), to household appliances and telecommunications equipment.

The EMI Receiver Series consists of two parts—the receiver RF section and the RF filter section. The two units are connected together via several cables on the front and rear panels to form a single instrument. All control for both units is handled by the receiver RF section, whether manually from the front panel or automatically through the interface bus.

For precompliance and diagnostic EMI applications which do not require a fully compliant CISPR Publication 16 receiver, the receiver RF section can be used as a stand-alone instrument. The receiver RF section has the EMI-specific functionality to perform these types of measurements. The receiver RF section can be upgraded to an EMI receiver by adding a RF filter section and sending the pair to an authorized HP service center for calibration verification.

Note

Before using your receiver, please use the *EMI Receiver Series Installation and Verification Manual* to ensure proper installation, including connections between the receiver RF section and RF filter section, configuration of the receiver, and verification of its operation.

Getting Acquainted with the EMI Receiver

Front-Panel Features

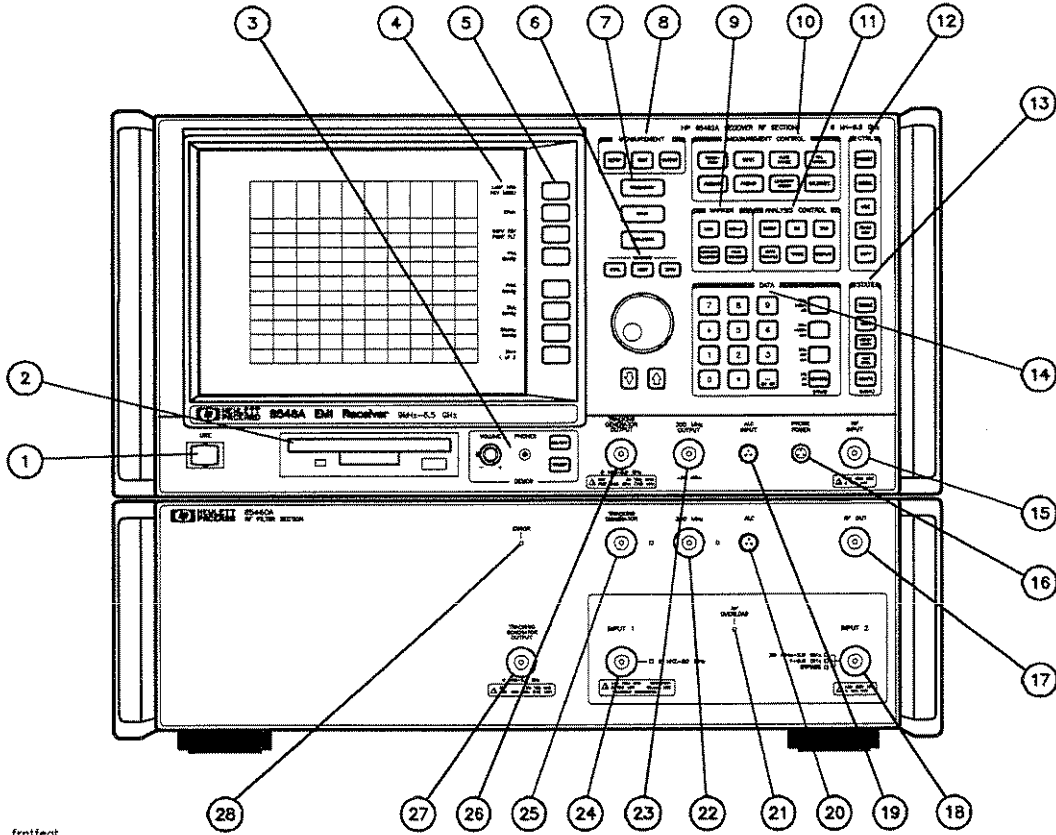

Figure 1-2. Front-Panel Feature Overview

The following section provides a brief description of front-panel features. Refer to Figure 1-2.

- 1 **LINE** turns the instrument on and off. An instrument self-check is performed every time the instrument is turned on. After applying power, allow the temperature of the instrument to stabilize for best measurement results.

Note

The instrument continues to draw power when it is plugged into the ac power source even if the line power switch is off.

- 2 **Disk drive** reads from or writes to a 3.5 inch floppy disk in MS-DOS or LIF format (initialized LIF disk is not 1.44 MByte).
- 3 **DEMODulation** control block includes an **ON/OFF** key for turning the demodulator on and off, a **SELECT** key to directly access the softkey menus that select AM or FM demodulation, FM gain, dwell time and squelch levels, a volume control knob, and a headphone jack.

- 4 **Softkey labels** are displayed on the screen next to the softkeys. Most of the labeled keys on the front panel of the receiver (also called front-panel keys) access menus of related softkeys.
- 5 **Softkeys** are the unlabeled keys next to the screen that activate the functions listed in the softkey menus.
- 6 **WINDOWS** keys including **CTRL** to turn on the windows display mode, **NEXT** for switching between windows and **ZOOM** for controlling the zone span and center frequency.
- 7 **FREQUENCY**, **SPAN**, and **AMPLITUDE** are the three large dark-gray keys that activate primary receiver functions and access the menus of related functions.
- 8 **MEASUREMENT** control block includes the three main keys used to make EMI measurements. The **SETUP** key accesses softkey functions that control the receiver settings to be used in a measurement, such as frequency range, antenna correction factors, and limit lines. The **TEST** key provides control for measuring signals and manipulating lists of measured signals. The **OUTPUT** key provides access to the report generator for graphical and tabular data output.
- 9 **MARKER** functions control the markers, read out frequencies and amplitudes along the receiver trace, automatically locate the signals of highest amplitude, and keep a signal at the marker position in the center of the screen.
- 10 **MEASUREMENT CONTROL** functions access special-function menus and self-calibration routines.
- 11 **ANALYSIS CONTROL** functions access menus that adjust the resolution bandwidth, adjust the sweep time, store and manipulate trace data, and control the instrument display.
- 12 **CTRL** functions affect the state of the entire receiver. The green **PRESET** key resets the receiver to a known state. **SAVE** and **RECALL** keys save and recall traces, states, limit-line tables, and amplitude-correction factors to or from a floppy disk or receiver memory.

TRACK GEN accesses the softkey menus that control the built-in tracking generator.

COPY prints or plots screen data. Use **CONFIG**, **Plot Config** or **Print Config**, and **COPY DEV PRNT PLT** before using **COPY**. Refer to descriptions for these softkeys in the *EMI Receiver Series Reference* manual for more detailed information.

Note

If you wish to reset the instrument configuration to the state it was in when it was originally shipped from the factory, use **DEFAULT CONFIG**. Refer to the **DEFAULT CONFIG** softkey description in the *EMI Receiver Series Reference* manual for more information.

- 13 **STATE** functions control features that affect the overall instrument state such as single sweep, instrument mode (receiver or signal analysis), user menus, FFT measurements, and instrument configuration.
- 14 **DATA** entries allow you to change the numeric value of an active function and can be made by using the numeric keypad, knob, or step keys.
- 15 **RF INPUT** is the signal input for the receiver RF section.

CAUTION

Excessive signal input will damage the receiver input attenuator and input mixer. Use extreme caution when using the receiver around high-power RF sources and transmitters. The maximum input power the receiver can tolerate appears on the front panel and should not be exceeded.

Excessive dc voltage can also damage the input attenuator. **DO NOT EXCEED** the maximum dc voltage specified on the receiver front panel (underneath the RF INPUT connector).

- 16 **PROBE POWER** provides power for high-impedance ac probes or other accessories (+15 VDC and -12.6 VDC).
- 17 **RF OUT** provides a filtered input signal for the receiver RF section. Normally, the RF OUTPUT is connected to the receiver RF section RF INPUT.
- 18 **INPUT 2** is a signal input for the receiver that sweeps from 20 MHz to 2.9 GHz, from 1 GHz to 6.5 GHz (for an HP 8546A only), or the full band (in bypass mode).
- 19 **ALC INPUT** provides a connection to the tracking generator leveling circuitry in the receiver RF section from the RF filter section. The receiver uses the tracking generator for performing instrument calibration.
- 20 **ALC** provides a connection to the tracking generator leveling circuitry in the receiver RF section from the RF filter section.
- 21 **RF OVERLOAD LED** lights up when an RF overload condition is detected. The LED is turned off when the signal amplitude is reduced or eliminated. This can be done by adding RF attenuation or filtering.
- 22 **300 MHz** is the calibration signal input from the receiver RF section.
- 23 **300 MHz OUTPUT** provides the 300 MHz calibration signal for the RF filter section.
- 24 **INPUT 1** is a signal input to the receiver. The frequency range of INPUT 1 is 9 kHz to 50 MHz.
- 25 **TRACKING GENERATOR** is a signal input for the tracking generator output of the receiver RF section.
- 26 **TRACKING GENERATOR OUTPUT** provides the built-in tracking generator output from the receiver RF section.

- 27 **TRACKING GENERATOR OUTPUT** provides the built-in tracking generator output from the EMI receiver.
- 28 **ERROR LED** lights when an improper command is sent to the RF filter section from the receiver RF section.

Data Controls

Data controls are used to change values for functions such as center frequency, marker position, and sweep time.

The data controls will change the active function in a manner prescribed by that function. For example, you can change center frequency in fine steps with the knob, in discrete steps with the step keys, or to an exact value with the number/units keypad.

Number/Units Keypad

The number/units keypad allows entry of exact values for many of the receiver functions. You may include a decimal point in the number portion. If not, the decimal point is placed at the end of the number.

Numeric entries must be terminated with a units key. The units keys change the active function in a manner prescribed by that function. For example, the units keys for frequency span are **[GHz]**, **[MHz]**, **[kHz]**, and **[Hz]**, whereas the units for reference level are **[+dB μ V]**, **[-dB μ V]**, **[mV]**, and **[μ V]**.

Note

If an entry from the number/units keypad does not coincide with an allowed function value (for example, that of a 12 MHz bandwidth), the receiver defaults to the nearest allowable value.

Knob

The knob allows continuous change of functions such as center frequency, reference level, and marker position. It also changes the values of many functions that only change in increments. Clockwise rotation of the knob increases values. For continuous changes, the extent of alteration is determined by the size of the measurement range; the speed at which the knob is turned does not affect the rate at which the values are changed.

The knob enables you to change the center frequency, start or stop frequency, or reference level in smooth scrolling action. The smooth scrolling feature is designed to move the trace display to the latest function value as the knob is turned. When either center frequency or reference level is adjusted, the signal will shift right or left or up or down with the rotation of the knob before a new sweep is actually taken. An asterisk is placed in the message block (the upper right-hand corner of the receiver display) to indicate that the data onscreen does not reflect the data at the current setting.

Note

When using the knob to change frequency or amplitude settings, the trace data is shifted. Therefore, when using **MAX HOLD A**, **MAX HOLD B**, or **MIN HOLD C**, moving the center frequency with the knob will not simulate a drifting signal.

Step Keys

The step keys allow discrete increases or decreases of the active function value. The step size depends upon the measurement range or on a preset amount. Each press results in a single step change. For those parameters with fixed values, the next value in a sequence is selected each time a step key is pressed. Changes are constant and can be set for some functions. Out-of-range values or out-of-sequence values will not occur when using these keys.

HOLD Key

The HOLD key deactivates functions. This key is designated as either the (ENTER) key in the data entry area on the receiver front panel or as a softkey in the (DISPLAY) menu. The active function readout is blanked, indicating no entry will be made inadvertently when using the knob, step keys, or numeric keypad. Pressing a function key reenables the data controls.

Rear-Panel Features

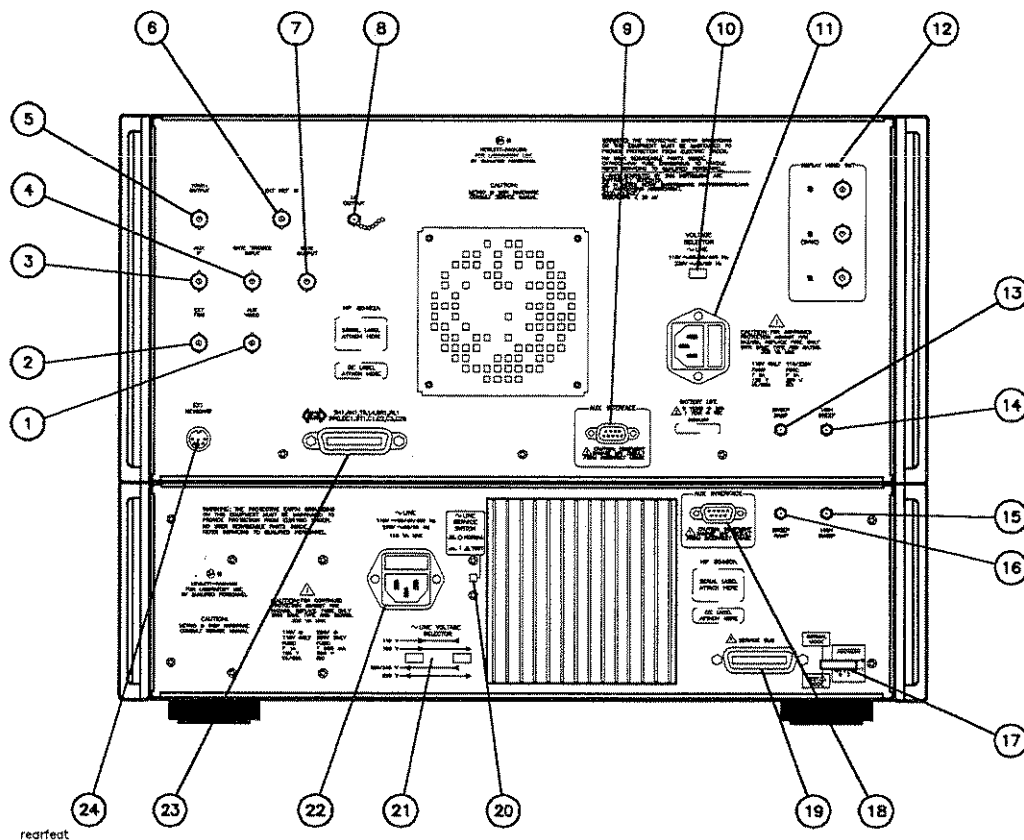

Figure 1-3. Rear-Panel Feature Overview

The following section provides a brief description of rear-panel features. Refer to Figure 1-3.

- 1 **AUX VIDEO** provides detected video output (before analog-to-digital conversion) proportional to vertical deflection of the trace. Output is from 0 V to 1 V.

Note

Amplitude-correction factors are not applied to the video output signal.

- 2 **EXT TRIG** accepts the positive edge of an external voltage input to trigger the receiver's internal sweep source.
- 3 **AUX IF** is the 50 Ω , 21.4 MHz IF output signal down-converted from the RF input of the instrument. Amplitude-correction factors are not applied to this signal.
- 4 **GATE TRIGGER INPUT** is not available.
- 5 **10MHz REF OUTPUT** provides a 10 MHz, 0 dBm minimum, time-based reference signal. This output is normally connected to EXT REF IN.
- 6 **EXT REF IN** accepts an external frequency source to provide the 10 MHz, -2 dBm to +10 dBm frequency reference used by the instrument.
- 7 **GATE OUTPUT** is not available.
- 8 **LO OUTPUT** provides the output of the first LO, which is proportional to the frequency that the receiver is tuned to. This output is normally terminated with an attached load.
- 9 **AUX INTERFACE** provides a nine-pin "D" subminiature connector for control of external devices (for example, HP 85460A) via the HP 85462A.

CAUTION

-
- Turn off the receiver before connecting the **AUX INTERFACE** connector to a device. Failure to do so may result in loss of factory-correction constants.
 - Do not exceed the current limits for the +5 V supply when using the **AUX INTERFACE** connector. Exceeding the current limits may result in loss of factory-correction constants.
 - Do not use the **AUX INTERFACE** as a video monitor interface. Damage to the video monitor will result.
-

- 10 **VOLTAGE SELECTOR** adapts the receiver RF section to the power source: 115 V or 230 V.
- 11 **Power input** is the input for the line power source. Make sure that the line-power source outlet has a protective ground contact. Refer to the *EMI Receiver Series Installation and Verification Manual* for instructions on selecting the correct setting.
- 12 **DISPLAY VIDEO OUT** connectors provide access for an external monitor (B,G, R, and SYNC).
- 13 **SWEEP RAMP** provides a voltage ramp proportional to the sweep and the receiver span (0 V to 10 V).

Horiz. 25 kHz Vert. 60 Hz
composite on G

- 14 **HIGH SWEEP** provides a voltage that indicates when the receiver is sweeping. This connection can also be grounded to stop sweeping.
- 15 **HIGH SWEEP** receives sweep control from the receiver RF section when configured as an EMI receiver.
- 16 **SWEEP RAMP** receives a voltage ramp from the receiver RF section when configured as an EMI receiver.
- 17 **ADDRESS switches** set the address of the service bus to allow communication between the RF filter section and an external computer via the receiver RF section, or the service-bus connector on the receiver RF section. Specific switch settings can also be used to initiate internal diagnostic service procedures. Refer to the *EMI Receiver Series Installation and Verification Manual* for detailed information on switch settings.
- 18 **AUX INTERFACE** provides a nine-pin "D" subminiature connector for control from the receiver RF section.
- 19 **SERVICE BUS** connector is an HP-IB connector that allows an external computer to communicate with the RF filter section to perform service and diagnostic tests only.
- 20 **LINE SERVICE SWITCH** turns on and off the operating mode of the RF filter section. NORMAL mode is selected for EMI receiver operation; TEST mode is selected when performing service and diagnostic tests via the SERVICE BUS.
- 21 **LINE VOLTAGE SELECTOR** adapts the RF filter section to the power source. Refer to the *EMI Receiver Series Installation and Verification Manual* for instructions on selecting the correct setting.
- 22 **LINE** power module is the input for the line power source. Make sure that the line-power source outlet has a protective ground contact. The primary line-power fuse is also located in this module.
- 23 **Interface connector** is an optional interface for either HP-IB (standard) or RS-232 (Option 023) interface buses that supports remote instrument operation and direct plotting or printing of screen data.
- 24 **EXT KEYBOARD** connector is used to connect a VECTRA C1405A, option ABA keyboard with a DIN-style plug to the receiver. The keyboard can be used to enter screen titles, prefixes, remote commands, and report annotation.

CAUTION

-
- Turn off the receiver before connecting an external keyboard to the receiver. Failure to do so may result in loss of factory calibration data.
 - Static discharges of greater than 3 kV to metallic portions of the connector housing on the keyboard during operation may cause the instrument to reset.
-

Screen Annotation

The following two figures indicate the primary annotation areas that may be displayed when using your receiver. Figure 1-4 shows the display in normal operating mode. Figure 1-5 shows the display when using windows.

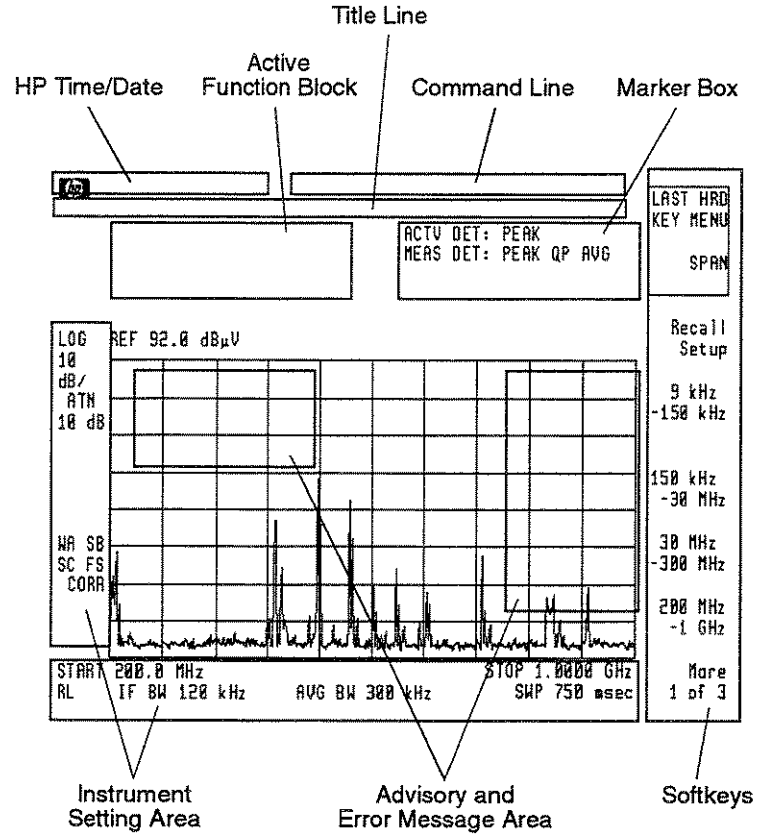
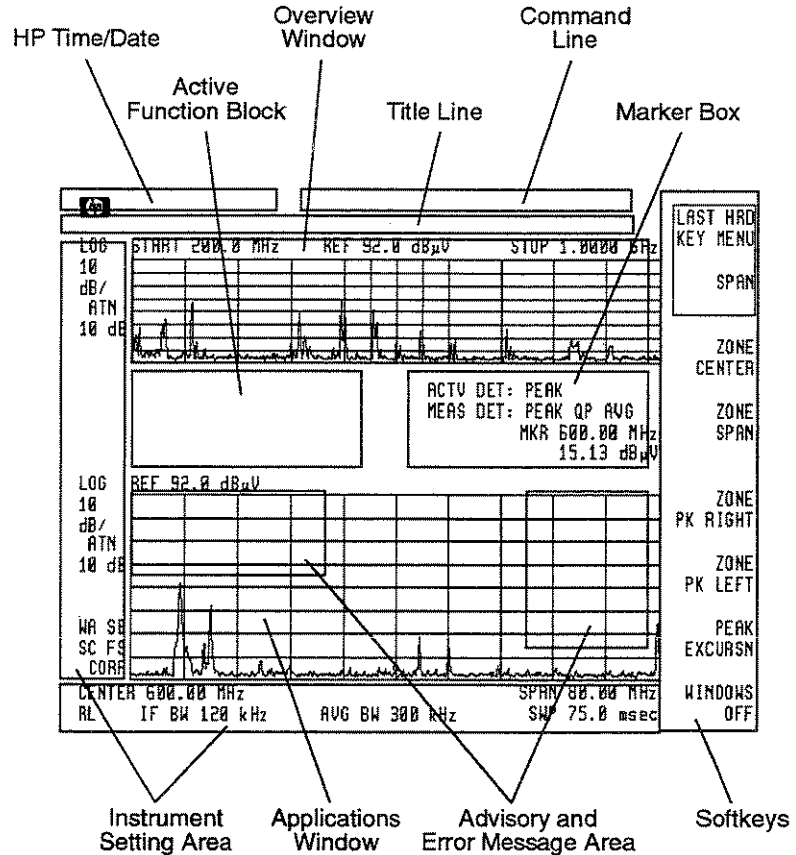

Figure 1-4. EMC Screen Annotation, Normal Operating Mode

CTRL activates the windows display mode and splits the screen into two separate displays—the top, overview window and the bottom, applications window. Only one window is active at a time. The active window is selected by toggling the **NEXT** key (under the WINDOWS front-panel keys).



windobxt

Figure 1-5. EMC Screen Annotation Using Windows

Receiver RF Section Annotation

The instrument preset conditions used in this manual are those of an HP 8542E or an HP 8546A EMI receiver. When using either an HP 85422E or an HP 85462A receiver RF section, operators will note discrepancies in reference level and sweep time when comparing the illustrations given in this manual to the displays presented on the instrument screen. These discrepancies are due to hardware differences between the two configurations.

Menu and Softkey Overview

The keys labeled SETUP, FREQUENCY, and MKR are all examples of front-panel keys. Pressing most front-panel keys access menus of functions that are displayed along the right side of the display screen. These menus are called softkey menus.

Softkey menus list functions other than those accessed directly by the front-panel keys. To activate a function on the softkey menu, press the unlabeled key immediately to the right of the annotation on the screen. The unlabeled keys next to the annotation on the display screen are called softkeys.

Throughout this manual front-panel keys are indicated by a box around the key label, for example, **AMPLITUDE**; softkeys are indicated by shading on the key label, for example, **REF LVL**. The softkeys displayed depend on the front-panel key pressed and which menu level is selected.

If a softkey function's value can be changed, it is called an active function. The function label of the active function appears on the display in inverse video. For example, if you press **AMPLITUDE** the softkey menu of related amplitude functions is displayed. Note the function labeled **REF LVL** appears in inverse video. The message "REF LVL" also appears in the active function block on the display, indicating it is the active amplitude function and can be changed using any of the data controls.

A softkey with ON and OFF in its label can be used to turn the softkey's function on or off. To turn the function on, press the softkey so that ON is underlined. To turn the function off, press the softkey so that OFF is underlined. An ON or OFF softkey function will be indicated throughout this manual as: **ANTENNA ON OFF ON**.

A function with AUTO and MAN in the label can either be auto-coupled or have its value manually changed. The function's value can be changed manually by pressing the softkey until MAN is underlined, and then changing its value with the numeric keypad, knob, or step keys. To set the function so that it operates automatically, press the softkey so that AUTO is underlined. An AUTO or MAN softkey function will be indicated throughout this manual as: **ATTEN AUTO MAN AUTO**.

When some softkeys, such as **SCR PWR ON OFF** and **SRC ATN MAN AUTO**, are pressed the first time, only the function will be highlighted. To change the value of the function use the numeric keys, step keys or knob. When entering a value with the numeric keys, the entry must be terminated by pressing one of the units keys, such as **dB** or **dB μ V**. When adjusting the value using the step keys or knob the units are entered automatically by the receiver. When you are finished entering or adjusting the value, press the softkey again to highlight the on and off or auto and manual functions.

A summary of all front-panel keys and softkeys can be found in Chapter 3, "Key Dictionary Reference," of the *EMI Receiver Series Reference* manual.

Disk Drive

The disk drive on the front panel of the receiver RF section is available for reading from or writing to a 1.44 MByte, 3.5 inch floppy disk in MS-DOS or LIF format.

Note

Only double-sided disks may be used.

The following tasks may be performed using the disk drive:

- Format a disk.
- Create a file.
- Differentiate between the different types of files when cataloged.
- Save and recall instrument setups.
- Save and recall lists of signal data, including frequency and peak, quasi-peak, and average amplitudes.
- Save and recall limit lines.
- Save and recall amplitude correction factors.
- Save and recall instrument traces.
- Save bitmap files (images) of display graphics.

Receiver RF Section Battery Information

The receiver RF section uses a 3.6 V lithium battery to enable the receiver memory to retain data. The date when the battery was installed is on a label on the rear panel of the instrument. (See Figure 1-6.)

The minimum life expectancy of the battery is 8 years at 25°C, or 1 year at 55°C. If you experience problems with the battery or the recommended time period for battery replacement has elapsed, see "Returning the EMI Receiver for Service" in the *EMI Receiver Series Installation and Verification* manual.

If you wish to replace the battery yourself, you can purchase the service documentation that provides all necessary test and maintenance information. The battery is soldered onto the receiver's processor board. Service documentation may be ordered through your HP sales and service office.

After replacing the battery, write the date of battery replacement on the rear-panel label.

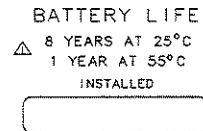

pu 132e

Figure 1-6. Rear-Panel Battery Information Label

Calibration

What You'll Learn in this Chapter

This chapter describes procedures for calibrating the HP 8542E/HP 8546A EMI receiver and the HP 85422E/HP 85462A receiver RF section. In this chapter you will:

- Calibrate the EMI receiver.
- Set the receiver clock.
- Set the AutoCal time.
- Perform the tracking generator self-calibration.
- Perform the YTF self-calibration. (HP 8546A or HP 85462A only.)
- Calibrate the receiver RF section.

Improving Accuracy

Data from the self-calibration routine is necessary for receiver operation. Regularly executing the self-calibration routine ensures the receiver is using current calibration data. This improves the receiver's frequency and amplitude accuracy. Press the **CALIBRATE** key to view the Self-Calibration Routine menus. The last softkey on this menu, **More 1 of 3**, provides access to additional self-calibration functions.

The self-calibration routines provide correction factors for internal circuitry. The application of the correction factors is required to meet frequency and amplitude specifications. When the correction factors are applied to internal circuitry the message "CORR" (corrected) is displayed on the left side of the screen.

The EMI receiver calibration consists of two parts.

- An receiver RF section frequency and amplitude calibration
- An RF filter section amplitude calibration

The receiver RF section frequency and amplitude calibration adjusts the frequency, sweep time, and span accuracy. It also adjusts bandwidth, switching between log and linear paths, IF gains, IF centering, RF attenuation, and the log amplifier.

The RF filter section amplitude calibration automatically adjusts amplitude levels to be within the calibration limits for the EMI receiver.

When is Self-Calibration Needed?

The following guidelines are intended to help you decide when to use the self-calibration features. Your specific measurement needs will determine your exact requirements.

- Perform the frequency and amplitude self-calibration routines whenever the instrument experiences significant environmental changes such as temperature ($\pm 5^\circ \text{C}$), humidity, shock, or vibration (which may occur during shipping or transport). This is particularly important if the frequency and amplitude self-calibration routines were last performed in a different environment.
- If the environment is relatively stable (for example, a laboratory environment), calibrate the receiver daily. Be sure to perform all receiver calibration procedures *after* operating temperature conditions are met.
- To achieve optimal amplitude accuracy for relative measurements:
 - Keep the receiver in a stable environment.
 - Retrieve the stored calibration data from memory before beginning the first measurement. Do *not* retrieve the calibration data prior to making subsequent measurements. (The amplitude drift is normally less than the calibration uncertainty.)
 - Keep the receiver turned on between measurements.
- If the input signal for EXT REF IN changes, run the frequency and amplitude self-calibration routines. Amplitude calibration is required to improve IF centering.
- If accurate self-calibration is temporarily needed in a different environment, calibrate the receiver RF section, but do not store the calibration data. The temporary correction factors will be used until the receiver is turned off, or until the calibration data is retrieved from memory.

For an HP 8546A/HP 85462A only.

- If preselector peaking has more than a 2-db effect on the signal amplitude when using single-band sweep mode above 2.9 GHz, perform the YTF self-calibration routine and then store the data. The YTF self-calibration routine improves the preselector default values.

Warm-Up Time

A one hour warm-up period is necessary after the receiver is turned on to ensure the receiver meets its specifications.

Note

Be sure to perform all receiver calibration procedures *after* operating temperature conditions are met.

Calibrating the EMI Receiver

When either the HP 8542E or HP 8546A is turned on, the receiver's amplitude calibration data for INPUT 1 and INPUT 2 is verified. If the data is valid, it is downloaded to the RF filter section from the nonvolatile storage in the receiver RF section. If the data is not valid, the RF filter section will use its standalone factory calibration data and display a "Cal Needed" message.

Note PRESET or IP does *not* download the receiver's calibration data.

Using **CAL FETCH**

To retrieve the receiver's calibration data from internal memory, press:

CALIBRATE
CAL FETCH

If the data is not valid when the calibration data is retrieved from memory using the cal fetch function, one or both of the following messages will be displayed:

INPUT 1: Data Not valid
CAL INPUT 1 required

INPUT 2: Data Not valid
CAL INPUT 2 required

Verifying the Receiver's Calibration

1. To verify the amplitude calibration data, press:

CAL CHECK

2. If the data is not valid, the calibration check procedure is stopped and the message "Cal Needed" is displayed.
3. If the data is valid, the calibration check is completed and the message "Calibration OK" is displayed.

Note Only the amplitude accuracy at 300 MHz ± 2 dB is verified when a **CAL CHECK** is executed. To ensure the receiver meets its specifications at all frequencies, a calibration must be performed.

Using CAL ALL

To calibrate the receiver, press:

CALIBRATE
CAL ALL

The calibration procedures take approximately 20 minutes to complete. When the calibration is successfully completed, the internal adjustment data is stored in volatile RAM and the following message is displayed.:

```
CAL ALL : done
INPUT 1 : Passed
INPUT 2 : Passed
Press CAL STORE to save
```

If the calibration procedure encounters a detectable error that prevents part of the receiver from meeting all of the specifications at all frequencies, the calibration *will be completed* and one of the following messages will be displayed.

```
CAL ALL : done
INPUT 1 : Failed
INPUT 2 : Passed
```

```
CAL ALL : done
INPUT 1 : Passed
INPUT 2 : Failed
```

```
CAL ALL : done
INPUT 1 : Failed
INPUT 2 : Failed
```

If the receiver encounters an error that will *not allow* the calibration to be completed, messages such as the following will be displayed:

```
CAL INPUT 1 : Data Not valid
CAL INPUT 1 required
```

```
INPUT CAL FAILED:
300 MHz out of range
```

```
INPUT CAL FAILED:
TG INT ALC out of range
```

```
INPUT CAL FAILED:
TG EXT ALC out of range
```

These messages tell you which sections of the receiver have encountered problems during the calibration procedure.

Using **CAL STORE**

When calibration is complete, the message "Press CAL STORE to save" will be displayed. To prevent the internal adjustment data from being lost when the receiver is turned off, press:

CAL STORE

The message "CAL: Stored" will be displayed.

If a problem was encountered while the calibration data was being saved, one of the following messages will be displayed.

Note

In the following messages, CAL 85422: Stored is displayed if you are calibrating an HP 8542E.

CAL 85462: Stored
CAL INPUT 1 : Not stored
INPUT 2 : Stored

CAL 85462: Stored
CAL INPUT 1 : Stored
INPUT 2 : Not stored

CAL 85462: Stored
CAL INPUT 1 : Not stored
INPUT 2 : Not stored

If one of these messages is displayed, it means either some of the calibration data is not valid or some of the data did not store successfully.

Interrupting calibration

To interrupt the calibration routines, press:

PRESET

CALIBRATE

CAL FETCH

The previous correction factors are retrieved.

Using the AutoCal Function

The AutoCal function enables you to select a time at which it would be convenient to have the calibration performed. If the Autocal function is ON when the receiver's internal clock reaches the "AutoCal Time," a calibration will be performed.

Setting the Receiver's Clock

1. To set the clock, press:

```
CONFIG
More 1 of 3
Time Date
Time Date ON OFF ON
SET TIME
```

Use the numeric keys to enter the time in an HHMMSS format, then press (ENTER) to terminate the entry.

2. To set the date, press:

```
SET DATE
```

Use the numeric keys to enter the date in an YYMMDD format, then press (ENTER) to terminate the entry.

Setting AutoCal Time

1. To set the time at which you wish to have the automatic calibration performed, press:

```
CALIBRATE
Cal At Time
SET TIME
```

Use the numeric keys to enter the time in an HHMMSS format, then press (ENTER) to terminate the entry.

2. To initialize automatic calibration, press:

```
AUTO CAL ON OFF ON
```

Note

When the automatic calibration function is ON, the calibration will be performed at the set time, even if the receiver is in use.

Performing a Partial Calibration

If only INPUT 1 or INPUT 2 is to be used, the following procedure may be used to save time.

For the HP 8542E only

CALIBRATE

More 1 of 3

CAL 85422

It will take approximately 10 minutes to complete the HP 85422E calibration. When the calibration is complete press the following keys:

CAL STORE

More 1 of 3

CAL INPUT 1 or **CAL INPUT 2**

For the HP 8546A only

CALIBRATE

More 1 of 3

CAL 85462

It will take approximately 10 minutes to complete the HP 85462A calibration. When the calibration is complete press the following keys:

CAL STORE

More 1 of 3

CAL INPUT 1 or **CAL INPUT 2**

When the partial calibration is complete, one of the following messages will be displayed.

CAL INPUT 1 (or 2): done
INPUT 1 (or 2): Passed

CAL INPUT 1 (or 2): done
INPUT 1 (or 2): Failed

To store the new calibration data, press:

CAL STORE

Note

In general, it is recommended the CAL ALL procedure be used to insure the system is calibrated for measurements from either input.

Performing the Tracking Generator Self-Calibration Routine

The following procedure can be used to calibrate the tracking generator.

1. To calibrate the tracking generator, connect TRACKING GENERATOR OUTPUT on the RF filter section to INPUT 2 using an appropriate cable and adapters. (To calibrate the receiver RF section as a standalone instrument, connect TG to RF IN.)

Note

A low-loss cable should be used for accurate calibration. Use the 50Ω cable shipped with the receiver.

2. Perform the tracking generator self-calibration routine by pressing the following keys:

`More 1 of 3`

`More 2 of 3`

`CAL TRK GEN`

If the tracking generator output is not connected to the receiver input, the message "TG SIGNAL NOT FOUND" is briefly displayed.

The tracking generator self-calibration routine lasts approximately two minutes.

3. To prevent the internal adjustment data from being lost when the receiver is turned off, press:

`CAL STORE`

Performing the YIG-Tuned Filter Self-Calibration Routine

For an HP 8546A/HP 85462A only.

The following procedure can be used to calibrate the YIG-tuned filter.

Note

All connections required for this procedure are internal.

1. To perform the YIG-tuned filter self-calibration routine, press:

`More 1 of 3`

`More 2 of 3`

`CAL YTF`

The YIG-tuned filter self-calibration routine lasts approximately two minutes.

2. To prevent the internal adjustment data from being lost when the receiver is turned off, press:

`More 3 of 3`

`CAL STORE`

Calibrating the Receiver RF Section as a Standalone Instrument

The following calibration is to be used only if you are using either the HP 85422E or the HP 85462A as a standalone instrument.

1. To calibrate the receiver RF section as a standalone instrument, press:

CALIBRATE

CAL ALL

The frequency and amplitude self-calibration routines take approximately nine minutes to finish. When the calibration is successfully completed, the internal adjustment data is stored in volatile RAM and a message is displayed.

2. To prevent the internal adjustment data from being lost when the receiver is turned off, press:

CAL STORE

To perform the frequency and amplitude self-calibration functions separately, press:

CALIBRATE

More 1 of 3

CAL FREQ or **CAL AMP**

Note

If the frequency and amplitude self-calibration routines are used, the frequency calibration should be performed *before* the amplitude calibration, unless the frequency data is known to be accurate.

3. The frequency calibration takes approximately two minutes. It adjusts the frequency, sweep time, and span accuracy. To start the frequency self-calibration procedure, press:

CAL FREQ

When the frequency calibration is complete, the preset display returns and "CAL DONE" is displayed.

4. The amplitude calibration takes approximately seven minutes. It adjusts bandwidth, switching between log and linear paths, IF gains, IF centering, RF attenuation, and the log amplifier. To start the amplitude self-calibration procedure, press:

CAL AMP

When the amplitude calibration is complete, the preset display returns and "CAL DONE" is displayed.

When the calibration is successfully completed, the internal adjustment data is stored in volatile RAM and a message is displayed.

5. To prevent the internal adjustment data from being lost when the receiver is turned off, press:

CALIBRATE

CAL STORE

After the frequency and amplitude self-calibration routines are complete, the message "CORR" (corrected) appears on the left side of the screen. This indicates the frequency and amplitude correction factors are being used. The correction factors can be turned off using the CORRECT ON OFF function. When OFF is underlined, most amplitude correction factors and some frequency correction factors are not used.

6. To calibrate the tracking generator, perform the procedure under "Performing the Tracking Generator Self-Calibration Routine".
7. If you have an HP 85462A, calibrate the YIG-tuned filter by performing the procedure under "Performing the YIG-Tuned Filter Self-Calibration Routine".

This completes the frequency and amplitude calibration procedure for the receiver RF section.

Making Compliance Measurements

What You'll Learn in This Chapter

This chapter describes how to configure the HP 8542E/HP 8546A EMI receiver to make compliance measurements, view and measure signals with the desired detectors, store these measurements to the internal list and create a report. The measurement examples presented in this chapter are:

- Setting Up a Measurement Using the SETUP Key
 - Using standard configurations
 - Customizing the standard configurations
 - Loading user-defined configurations from a disk
 - Loading a limit line from a disk
 - Loading an amplitude correction factor file from a disk
 - Activating the windows display format
 - Saving a setup to disk
- Making a Measurement Using the TEST Key
 - Tuning the receiver
 - Using a marker to tune the receiver and mark a signal
 - Making a measurement, saving the data in the list, and viewing the list
- Creating a Report Using the OUTPUT Key
 - Configuring a printer or plotter
 - Defining and producing a report

Note

An EMI receiver is required to make compliance measurements. Measurements made with only the receiver RF section may not meet the requirements of some regulatory agencies.

Introducing the SETUP, TEST, and OUTPUT Keys

The functions associated with the **SETUP**, **TEST**, and **OUTPUT** keys have been optimized to match the operations found in nearly all EMI measurements. These functions make it possible to gather and output data with a minimum number of keystrokes. The centralization of control provides a fast, easy way for you to configure the receiver, gather data and generate reports. It also provides a base from which to learn the other powerful measurement and diagnostic features of the receiver. The examples in this section describe both the use of these functions and their interactions with other features of the instrument.

Setting Up a Measurement Using the SETUP Key

To prepare the EMI receiver to make compliance measurements, the instrument settings must be appropriately configured. Optional procedures include displaying limit lines, activating amplitude-correction factors and opening the measurement windows.

The first level of menus, accessed by pressing the **SETUP** key, provide standard and user-defined configurations. The second and third levels allow you to modify the standard configurations, and use limit lines and amplitude correction factors.

Using Standard Configurations

The EMI receiver provides four standard instrument configurations which simplify the process of preparing the receiver to make measurements. The configurations are based on standard frequency ranges and are automatically selected by pressing the appropriate softkey. The settings unique to each configuration are shown in Table 3-1.

Table 3-1.
HP 8542E/HP 8546A Standard Configurations

MENU LABEL Start/Stop Frequency	IF Bandwidth	Averaging Bandwidth	Reference Level
9 kHz–150 kHz	200 Hz CISPR	300 Hz	70 dB μ V
150 kHz–30 MHz	9 kHz CISPR	30 kHz	75 dB μ V
30 MHz–300 MHz	120 kHz CISPR	300 kHz	80 dB μ V
200 MHz–1 GHz	120 kHz CISPR	300 kHz	80 dB μ V

The instrument preset values are:

- Peak detector displayed
- Peak, quasi-peak and average detectors available (for more information, refer to "Selecting the Measured Detectors" later in this chapter)
- Preamplifier off
- RF and IF overload detection on
- Autorange off

The settings common to all standard configurations are:

- 10 dB input attenuation
- Marker ON
- dB μ V units

Customizing the Standard Configurations

The standard configurations can be modified to meet specific requirements. Frequency parameters (start, stop, and center span) are changed using the menus associated with the FREQUENCY key.

1. Set the receiver to a known state by pressing:

```
PRESET
SETUP
200 MHz-1 GHz
INPUT
VIEW CAL ON OFF ON
```

Modifying Start and Stop Frequencies

2. To change the start frequency, press:

```
FREQUENCY
START FREQ ..... 150 MHz
```

3. To change the stop frequency, press:

```
STOP FREQ ..... 1100 MHz
```

Modifying Reference Level and Input Attenuation

4. To set the reference level and input attenuation, press:

```
AMPLITUDE
```

5. To change the reference level, press:

```
REF LVL ..... 90 dB $\mu$ v
```

6. To increase the input attenuation, press:

```
ATTEN AUTO MAN MAN ..... 20 dB
```

Modifying IF and Averaging Bandwidths

The EMI receiver offers measurement (CISPR) and diagnostic IF bandwidths as well as post-detection averaging bandwidths. The receiver defaults to the measurement bandwidth appropriate for the current center frequency.

7. To select a different bandwidth, press:

BW

8. Each measurement bandwidth has its own softkey. To select a specific measurement bandwidth, press the appropriate key. To change to a diagnostic IF bandwidth, press:

IF BW AUTO MAN MAN 100 **kHz**

9. Bandwidths may be selected by entering the desired value using the numeric keypad followed by the appropriate terminator, or by using the step keys or knob. To return the receiver to the default setting, press:

IF BW AUTO MAN AUTO

10. The receiver selects an averaging bandwidth appropriate for the selected IF bandwidth. To select a different averaging bandwidth, press:

AVG BW AUTO MAN MAN 100 **kHz**

11. To set the receiver to the default setting, press:

AVG BW AUTO MAN AUTO

Selecting the Active Detector

The EMI receiver can scan any one of the three available detectors. The currently active detector is indicated onscreen in the upper right-hand corner as the "ACTV DET." Refer to Figure 3-1. The default detector of the receiver is the peak detector. The peak detector scans the measured spectrum faster than the other built-in detectors because of its short charge and discharge time constants. To scan with the built-in quasi-peak or average detectors, press the **QUASI-PEAK** or **AVGERAGE** detector keys located in the upper portion of the front panel. When using these detectors, the receiver scans at a much slower rate due to longer time constants. Scan times are automatically selected to match the increased charge and discharge times. When making diagnostic measurements, it is possible to scan these slower detectors at a faster rate by reducing the sweeptime. The receiver will indicate this condition by displaying a "MEAS UNCAL" error message, as shown in Figure 3-1.

Note

When using the receiver RF section by itself, refer to "Receiver RF Section Annotation" in Chapter 1 of this manual.

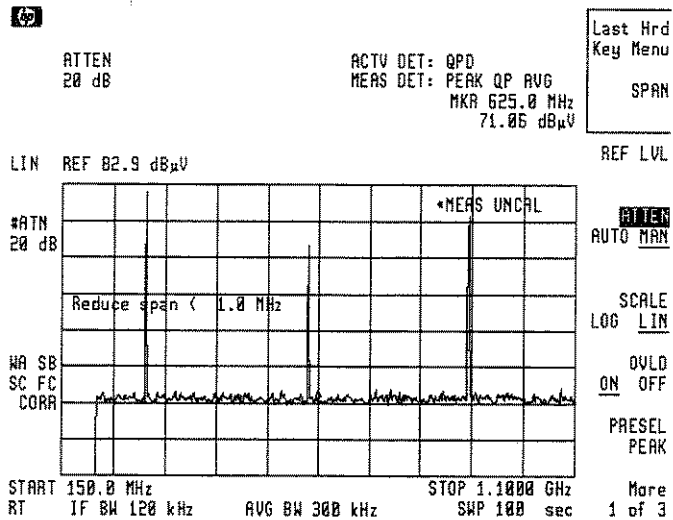

Figure 3-1. Active Detector and Measured Detector Messages

Selecting the Measured Detectors

The MEASURE AT MKR softkey can be used to measure any of the three available detectors. The detectors selected to be measured are displayed in the upper right-hand corner of the screen labeled "MEAS DET". Refer to Figure 3-1. The default configuration makes all three detectors active. Selecting only the detectors you need reduces measurement time. The dwell time for each detector may be set independently.

12. To select the detectors to be measured and their dwell times, press:

SETUP
More 1 of 3
Inst Setup
Measure Detector

13. Locate the DETECTOR PK QP AV softkey.

Notice each of the detector labels are underlined. This indicates they will all be measured.

Press the softkey. Notice some detectors are *not* underlined, and the detectors indicated next to MEAS DET onscreen have changed.

Continue pressing the softkey to observe the different possible combinations of detectors. When you are finished examining the combinations, make all three detectors active by pressing the following softkey until all three detectors are underlined.

DETECTOR PK QP AV PK QP AV

Measuring Detector Dwell Times

14. To modify the peak detector dwell time, press:

PK DWELL TIME Enter the desired dwell time.

The current dwell time is indicated in the active function block.

15. To modify the dwell times for the quasi-peak and average detectors, press:

QP DWELL TIME Enter the desired dwell time.

AV DWELL TIME Enter the desired dwell time.

The current dwell time is indicated in the active function block.

Note

The dwell times are added to the time required to obtain a valid detector reading, as dictated by the specific charge and discharge time constants. The total dwell time *cannot* be set below the required minimum value.

Controlling the Preamplifier

The preamplifier can be controlled from both the **PREAMP** key and the **PREAMP ON OFF** softkey located under the **SETUP** key. A message appears at top of the display to indicate the preamplifier is on. Refer to Figure 3-2.

16. To turn the preamplifier on, press:

PREAMP

Notice the change in reference level. Press this key again to turn the preamplifier off.

17. The following procedure can also be used to turn the preamplifier on.

SETUP

More 1 of 3

Inst Setup

PREAMP ON OFF ON

18. To turn the preamplifier off, press:

PREAMP ON OFF OFF

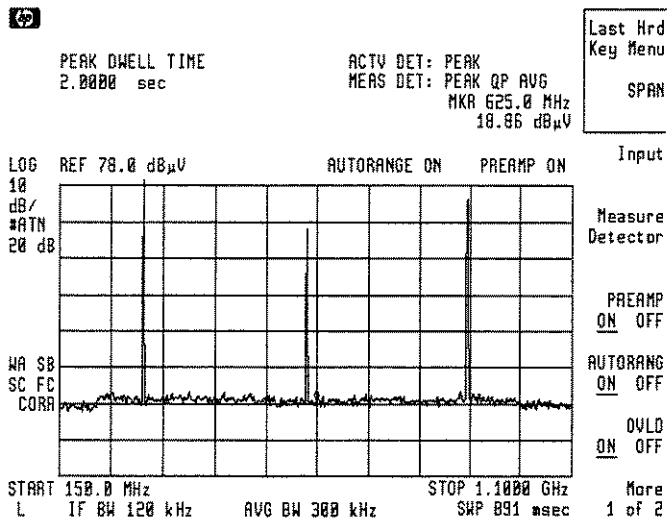

Figure 3-2. "PREAMP ON" and "AUTORANGE ON" Messages

Controlling Autoranging

The autoranging feature allows the instrument to automatically change its sensitivity as needed to remove any RF or IF overloads that occur during operation. The instrument will perform one autoranging activity per scan until the instrument is no longer in overload. To maximize sensitivity when the displayed frequencies are changed, the autoranging function will remove any corrective actions that were taken earlier, then autorange for the new conditions. A message appears at the top of the display when autoranging is on. Refer to Figure 3-2.

19. To activate autoranging using the front-panel key, press:

AUTORANGE

Press this key again to turn autoranging off.

20. The following procedure can also be used to activate autoranging:

SETUP

More 1 of 3

Inst Setup

AUTORANG ON OFF ON

Loading User-Defined Configurations from a Disk

User-defined configurations are useful if you regularly make measurements using the same setup. They are also useful when you wish to standardize measurements for multiple operators or locations. User-defined settings include:

- instrument state
- windows state
- limit lines (including testing status)
- amplitude correction factors

The disk drive can be used to store user-defined settings. Refer to Chapter 11 for more information.

1. To select a user-defined setting from a disk, insert the disk into the drive and press:

SETUP
RECALL SETUP

The receiver will catalog all setup files resident on the disk. Use the step keys or knob to highlight the desired file.

2. To load the desired setup, press:

LOAD FILE

Using Limit Lines

Two limit lines with margins can be displayed on the EMI receiver. These limit lines can be used to visually determine whether displayed signals meet the appropriate limits. Margins are set relative to each of the limit lines, and are useful when taking into account any uncertainties that can exist in the entire measurement system.

If you wish to provide a margin of safety when testing to a limit, you may set a margin below the required limit. When the limit-test function is activated, the EMI receiver automatically indicates onscreen whether or not a displayed signal passes or fails a displayed limit line or margin. When limit testing is activated, the receiver automatically tests to either the limit line or the margin, whichever is lowest. Failures are indicated both onscreen and over the HP-IB bus. When performing limit testing with two limit lines and their associated margins, the receiver automatically tests to the lowest of the four.

Note

When using the limit-test function, it is important to keep track of which detector output is being tested against which limit line. The peak detector is the default detector, however, most commercial limit lines indicate acceptable quasi-peak or average detector output levels. When viewing the peak detector output, it is possible to trigger a limit failure when testing against a quasi-peak limit line. This type of failure only indicates the need to remeasure the signal with the quasi-peak detector. It is quite possible for the peak value of an impulsive signal to exceed a quasi-peak limit, while the quasi-peak value of that same signal remains below the limit.

Refer to Chapter 8 for more information on entering and editing custom limit lines.

Loading a Limit Line from the Disk

1. Set the receiver to a known state by pressing:

```
PRESET
SETUP
200 MHz-1 GHz
AUTORANGE
```

2. Access the limit-line menu by pressing:

```
SETUP
More 1 of 3
Limit Lines
```

3. Insert the Limit Lines and Antenna Factor Library Disk into the disk drive. Load the EN55022 Class A Radiated, 10 m limit file from the disk by pressing:

```
RECALL LIMIT
```

Highlight EN022A10.LIM using the step keys or knob.

4. To load the file, press:

```
LOAD FILE
```

The receiver will automatically turn the limit lines on after it has finished loading the file.

5. Enter a -3 dB margin limit relative to limit line 1 by pressing:

```
Limit 1
MARGIN 1 ON OFF ON ..... 3 dB
```

The dotted margin line is displayed below the limit line. It can also be adjusted using the knob.

6. Turn limit testing on by pressing:

```
LMT TEST ON OFF ON
```

7. Test the functionality of limit-line testing using the internal calibrator signal by pressing:

INPUT
VIEW CAL ON OFF ON

The message "FAIL MARGIN 1" is displayed because the calibrator signal exceeds the margin line.

8. Turn the margin off by pressing:

SETUP
More 1 of 3
Limit Lines
Limit 1
MARGIN 1 ON OFF OFF

The message "FAIL LIMIT 1" is displayed because the calibrator signal now exceeds the limit line.

9. Turn the internal calibrator signal off by pressing:

INPUT
VIEW CAL ON OFF OFF

The message "PASS LIMIT" is displayed because no onscreen signals exceed the limit line.

Using Amplitude Correction Factors

The EMI receiver can correct the displayed data to take into account the effects of any transducers used when making measurements. The corrections are made real-time, as the data is displayed onscreen. The EMI receiver allows three types of amplitude-correction factors to be applied to the input signals.

Antenna Factors	Conversion factors relating field strength to measured voltage.
Cable Factors	Conversion factors to correct for cable insertion loss.
Other Factors	Correction factors to account for the effects of any other two-port device placed between the antenna and the receiver.

Note

A total of 80 correction frequencies can be specified. They can be distributed among the three categories in any combination. A matrix of correction frequencies and amplitudes is entered for each category desired. The receiver automatically sums the matrices and applies the net correction factor to the displayed data.

The amplitude-correction factor applied to the lowest selected frequency is also applied to all frequencies *below* the lowest selected frequency. The amplitude-correction factor applied to the highest selected frequency is also applied to all frequencies *above* the highest selected frequency. Refer to Chapter 9 for more detailed information.

Loading an Amplitude Correction Factor File from a Disk

Matrices can be loaded from a disk or entered from the front panel. The following procedure describes how to load an antenna factor matrix from the Limit Line and Antenna Factor Library Disk.

1. Set the receiver to a known state by pressing:

PRESET

SETUP

200 MHz—1 GHz

2. Access the correction factors menu by pressing:

More 1 of 3

Correctn Factors

3. Insert the Limit Lines and Antenna Factor Library Disk into the disk drive.
4. Load the HP 11966D periodic antenna 200 MHz—1 GHz file from the disk by pressing:

Antenna Factors

RECALL ANTENNA

5. Highlight “LOG_PERD.ANT” using the step keys or knob.
6. To load the file, press:

LOAD FILE

The receiver will automatically activate the correction factors after the file has been loaded. The noise floor will rise accordingly.

Note

Amplitude-correction factors are turned off when VIEW CAL is turned on.

Activating the Windows Display Format

The windows display format can be used to provide a simultaneous display of both the entire frequency range of interest and a detailed subset of that range. This display format helps you keep track of all the signals in the entire spectrum while making measurements on a specific signal. When the windows display format is first activated, the initial trace is transferred into the upper overview window and a frequency span that is one-tenth the width of the current trace is actively scanned in the lower applications window. The span of the applications window is centered around either the center frequency of the overview window or the marker frequency that was active in the initial trace. All limit line and amplitude correction information that was active in the initial trace is automatically transferred to both the overview and applications window.

When using the windows display format, the information detailing the state of each window is simplified. Use the **ZOOM** key to expand the active display to full screen. A complete description of the window state is provided when in this full screen mode. Press the **ZOOM** key again to return to the windows display mode.

1. Before activating the windows display format, set the receiver to a known state by pressing:

PRESET
SETUP
200 MHz - 1 GHz
AUTORANGE
INPUT
VIEW CAL ON OFF ON
PEAK SEARCH

2. To activate the windows display format, press:

CTRL

Notice the initial trace has been moved to the overview window, and a ten percent span of that trace, centered around the marker, has been moved into the applications window.

3. To activate the overview window, press:

NEXT

The outline of the overview window is now highlighted, showing it to be the active window.

4. Activate the lower applications window again by pressing:

NEXT

The outline of the lower applications window is now highlighted.

By repeatedly pressing this softkey, the active trace control toggles between the upper overview window and the lower applications window.

5. To activate the zoom function, press:

ZOOM

Complete annotation of the active window state is provided when in the full-screen mode.

Press the **ZOOM** key again to return to the windows display mode.

6. To turn the windows mode off, press:

CTRL

WINDOWS OFF

Making a Measurement

The main functions necessary for making compliance measurements are located under the **TEST** key. These functions allow you to tune the receiver, change the display of a signal by turning the scan on and off, point to the signal of interest with the marker, make a measurement of that signal, and enter that measurement into a data list.

Tuning the Receiver

1. To access the measurement softkeys, press:

TEST

2. To tune to a new center frequency, press:

TUNE SLO FAST

and either,

- enter the desired value using the numeric keypad
- use the step keys
- rotate the knob to the desired center frequency

When entering a value with the numeric keys, the entry must be terminated by pressing one of the units keys, such as **MHz** or **GHz**. When adjusting the value using the step keys or knob the units are entered automatically by the receiver.

When the knob is used to enter the frequency two tuning rates are available, slow and fast.

3. To change the rate at which the receiver tunes when using the knob, press:

TUNE SLO FAST FAST

The slow rate is the default rate. It is calculated by the receiver and is based on the scan width and the IF bandwidth. The fast rate is eight times greater than the slow rate.

You may toggle between the two rates by repeatedly pressing the **TUNE SLO FAST** softkey. The selected speed will be retained until it is changed, or an instrument preset is performed.

Note

The frequency of the receiver can also be changed by using the **CENTER**, **START**, and **STOP** functions. These functions are accessed by pressing the **FREQUENCY** key. The **SPAN** function, accessed by pressing the **SPAN** key, or the default user-softkey, can also be used to change the frequency of the receiver.

Using the Marker to Tune the Receiver

The marker function has two modes of operation. In tune mode, the receiver retunes the center frequency while maintaining the current span when the marker is moved to either edge of the display. This is the default mode. In span mode, the receiver will *not* retune the receiver when the marker is moved to either the start or stop frequency of the current span.

1. To see how the tune and span modes work, set the receiver to a known state by pressing:

PRESET

2. To use the internal calibrator as the test signal, press:

INPUT

VIEW CAL ON OFF ON

3. Use the marker to point to the 300 MHz calibrator signal by pressing:

TEST

MARKER TUNE SPN 300 MHz

4. Turn the windows display mode on by pressing:

CTRL

The 300 MHz calibrator signal is displayed in the center of the lower window. The frequency span is 80 MHz.

5. Select the marker tune mode by pressing:

TEST

MARKER TUNE SPN TUNE

6. Rotate the knob clockwise until the marker reaches the right side of the window. As you continue to rotate the knob the receiver changes frequencies. The zone marker is also moving in the upper overview window indicating the frequency range being displayed.
7. Continue rotating the knob until the 600 MHz calibrator signal is located in the center of the display.
8. Press the up-arrow (\uparrow) step key. The marker moves to the right edge of the display.
9. Press the up-arrow (\uparrow) step key, again. The receiver retunes and the marker moves to the left edge of the display.
10. Continue pressing the up-arrow (\uparrow) step key until the 900 MHz calibrator signal is displayed on the screen.
11. To change the marker mode to span, press:

MARKER TUNE SPN SPN

Note that when the knob is rotated counter-clockwise the receiver does *not* retune when the marker reaches the edge of the display.

Using the Measure at Marker Function

The measure-at-marker function uses a built-in algorithm to simplify the process of taking data. Measurements are made by placing the marker on the signal of interest and then selecting the measure-at-marker function. The algorithm:

1. locates the signal of interest
2. turns the scan off at that signal
3. optimizes the measurement dynamic range
4. measures all detectors currently selected
5. displays the results in the onscreen marker box

The marker box remains on the screen until the marker position or receiver tuning is changed. The measure-at-marker results can be saved to the internal list by pressing **ADD TO LIST**. The contents of the internal list can be viewed and remeasured, as desired. Refer to Chapter 5 for more information.

The dwell time used for each detector can be adjusted using the dwell time function. Refer to the “Customizing Standard Settings” section earlier in this chapter for more information.

The following example shows how to:

- use the measure-at-marker function
- use the marker box
- store signals in the list
- view signals in the list

1. Set the receiver to a known state by pressing:

PRESET

2. Turn on the internal calibrator signal to use as a test signal by pressing:

INPUT

VIEW CAL ON OFF ON

3. Activate the marker by pressing:

TEST

MARKER TUNE SPN TUNE

4. Rotate the knob until the marker is on the peak of the 300 MHz calibrator signal.

5. Measure the signal at the marker by pressing:

MEASURE AT MKR

The measured detector values are displayed on the screen in the marker box. Refer to Figure 3-3.

6. Save the measurement to the list by pressing:

ADD TO LIST

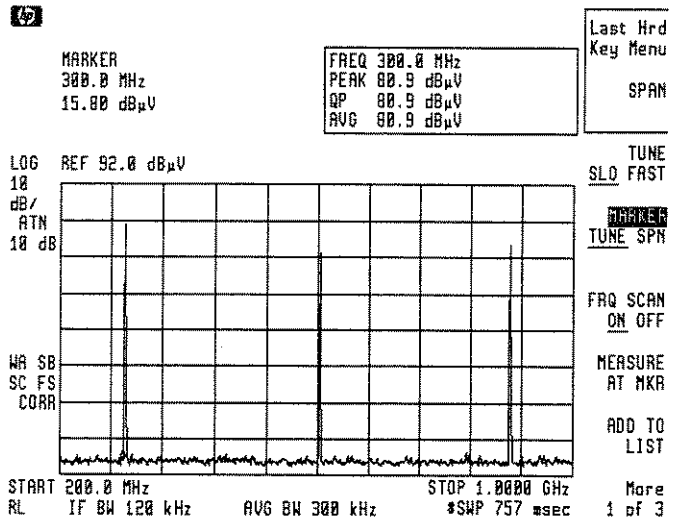

Figure 3-3. Using the Measure at Marker Function

7. Rotate the knob until the marker is on the peak of the 600 MHz calibrator signal, and then press:

MEASURE AT MKR

8. When the receiver displays the measured values, press:

ADD TO LIST

9. Rotate the knob until the marker is on the peak of the 900 MHz calibrator signal, and then press:

MEASURE AT MKR

10. When the receiver displays the measured values, press:

ADD TO LIST

11. Change the displayed span by pressing:

SPAN 10 **MHz**

12. View the signals entered into the list by pressing:

TEST

More 1 of 3

SIG LIST ON OFF ON

Use the step keys to step through the list. The receiver highlights the selection and automatically tunes to the indicated frequency. Refer to Chapter 5 for more information.

Note

-
- The measure-at-marker function uses an algorithm to sequentially reduce the frequency span until the peak of the signal of interest is displayed. After each span reduction, the marker moves to the largest signal present on the display. The receiver indicates which signal it measured by leaving the marker at that signal. If you are measuring a small signal in the presence of a large signal the algorithm may measure the larger signal. If this situation occurs, reduce the span until the larger signal is one major frequency division away from the smaller signal.
 - If using the Measure at Marker function to measure a pulsed signal with a repetition frequency of less than 5 Hz, set the sweep time to greater than or equal to the inverse of the pulse repetition frequency. (For example, to measure a 1 Hz CISPR pulse, set the sweep time to 1 second or greater prior to using the Measure at Marker function.)
 - Strong adjacent signals can affect measurement accuracy. The measure-at-marker algorithm detects when these signals may be interfering with the measurement and displays the message, "Strong adjacent signal" in the lower left-hand corner of the display. The effects of strong signals can be reduced by increasing the input attenuation, or, when making diagnostic measurements, by reducing the IF bandwidth.
-

Creating a Report

Data collected in the internal list can be printed in a report. The report can consist of any of the following elements:

- the user comments (annotations)
- a tabular list of the data
- a graph of the data in the list on either a linear or logarithmic frequency axis with the limit lines that are currently displayed
- a listing of the instrument setup parameters, including limit-line and amplitude-correction files

Note

Only the graph can be sent to a plotter.

Configuring a Printer

The instrument supports a variety of printers. The receiver must be configured correctly to operate with a specific printer type. Configuration options include:

- printer type
- HP-IB address of the printer
- number of plots per page
- color or monochrome output

The configuration information is used when printing with either the **COPY** key or the OUTPUT REPORT softkey (located on the **OUTPUT** key menu).

The following procedure configures the receiver to print to an HP ThinkJet printer.

1. Access the printer configuration menu by pressing:

CONFIG

2. To use a ThinkJet printer, press:

Print Config

Printer Type

THINKJET

Config Done

Note

The default printer is the HP DeskJet 550C.

3. Set the HP-IB address of the printer. Enter the last two numbers of the address assigned to the printer. For example, if the printer address is 701, enter 01 by pressing:

PRINTER ADDRESS 01

4. Confirm the entry by pressing:

ENTER

Configuring and Generating a Report

Use the list that was created in the “Using the Measure at Marker Function” section earlier in this chapter for this procedure.

1. Access the report definition menu by pressing:

OUTPUT
Define Report

2. Verify that all report definitions are set to on (default mode), by selecting the following softkey settings:

ANNOTATN ON OFF ON
LOG ON OFF ON
LIN ON OFF ON
LIST ON OFF ON
SETTINGS ON OFF ON

3. To modify the list, press:

Previous Menu
Define List

The display of the data in the list can be tailored to meet your needs. You can:

- Select which of the measured detectors to print to the list.
- Display the differences between a data point and the limit lines, for any of the detectors.
- Elect to indicate which of the list entries have been “marked,” (refer to Chapter 4 for more information).
- Print the current correction factors used.

4. To modify which detector values are printed to the screen, press:

SHOW DET PK QP AV

The detectors that will be displayed are underlined (defaults are PK and QP). Press the softkey repeatedly to view the detector combinations available.

5. When limit lines are active, the numerical difference between a specific detector reading and limit line 1 can be included in your report by pressing:

SHOW Δ1 PK QP AV

The detectors that will be displayed are underlined. Press the softkey repeatedly to view the detector combinations available.

6. To include the numerical difference between a specific detector reading and limit line 2 in the report, press:

SHOW Δ2 PK QP AV

The detectors that are currently detected are underlined. Press the softkey repeatedly to view the detector combinations available.

7. To include the total current correction factor used for the data point displayed in the report, press:

SHOW COR ON OFF ON

8. To include the “mark” in the report, press:

SHOW MRK ON OFF ON

Note

When the maximum number of columns exceeds the maximum number of characters available across a page in portrait orientation, the receiver will print the data in landscape orientation. The Thinkjet printer does not support landscape orientation, and the maximum number of columns that can be printed in portrait mode on this printer is nine.

9. To return to the top level OUTPUT menu, press:

Previous Menu

10. To add user notes to the report, press:

EDIT ANNOTATN

Annotation is entered with a keyboard. The maximum number of ASCII characters allowed in the annotation is 1024. For more information on connecting and using the keyboard, refer to Chapter 12.

11. To clear any existing annotation, press:

CLEAR ANNOTATN

12. When you finish entering notes, press:

EXIT EDIT

13. Verify the printer is connected to the receiver, then output the report by pressing:

OUTPUT REPORT

14. To halt the operation at any time during the output cycle, press:

ABORT

The receiver will finish any graphs currently in process before aborting the output cycle.

List-Based Measurements

Radiated emissions measurements revolve around signal lists. The key output of the testing process is a list of the highest amplitude signals from the equipment under test. It is this list of signals which regulatory agencies of the world are interested in. The list-based measurement feature includes the following features:

- Add signals to the list.
- View the signal list table at any time.
- Sort the signal list.
- Delete signals from the list.
- Mark signals on the list.
- Remeasure signals on the list.
- Save the tabular list to disk and recall it.
- Graph the signal list on a logarithmic or linear scale.
- Save the signal list graph to disk.

When viewing the signal list table, both list and trace information are viewed at the same time. The signal list is displayed in the upper half of the display screen; the lower half of the display screen is the active window with a live trace. Furthermore, as each signal in the list is selected, the frequency of the signal is used to tune the active window. If the frequency is already on-screen, just the marker is moved, otherwise the tune frequency is changed.

For the purpose of this measurement example, the 300 MHz calibrator signal and its harmonics will be used to build a signal list.

Note

Before performing this measurement example, make sure that the signal list is empty by pressing the following keys:

TEST

More 1 of 3

EDIT LIST (If table is empty, go to step 1.)

Delete Signals

DELETE ALL SIGS

DELETE ALL SIGS

1. Preset the instrument to a known state by pressing:

PRESET

2. Activate the 300 MHz calibrator signal and its harmonics by pressing:

INPUT

VIEW CAL ON OFF ON

Note

When using the receiver RF section by itself, refer to “Receiver RF Section Annotation” in Chapter 1 of this manual.

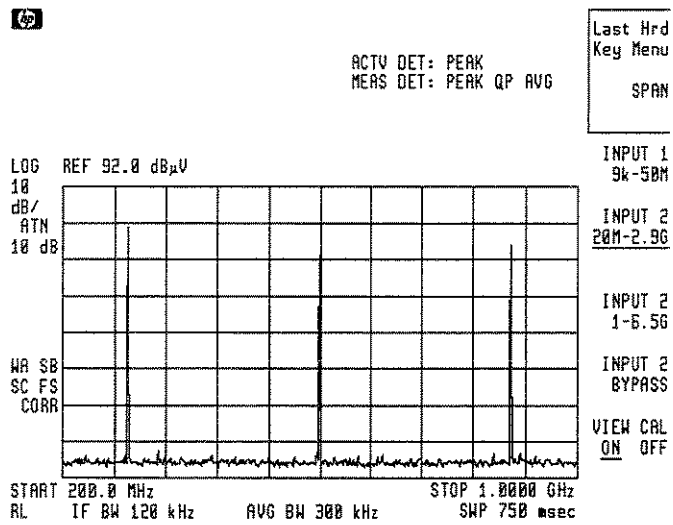

300 MHz Calibrator Signal

3. Set the receiver stop frequency to 2.9 GHz in order to view additional harmonic signals by pressing:

FREQUENCY

STOP FREQ 2.9 **GHz**

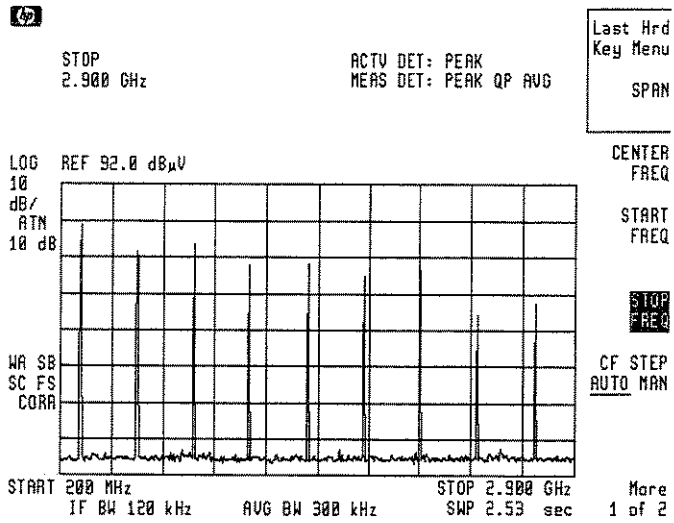

300 MHz Calibrator Signal with Harmonics

- Place a marker on the 300 MHz calibrator signal by pressing:

PEAK SEARCH

Adding Signals to the List

- Measure the peak, quasi-peak, and average detectors for this signal peak by pressing:

TEST

MEASURE AT MKR (wait for results to be displayed)

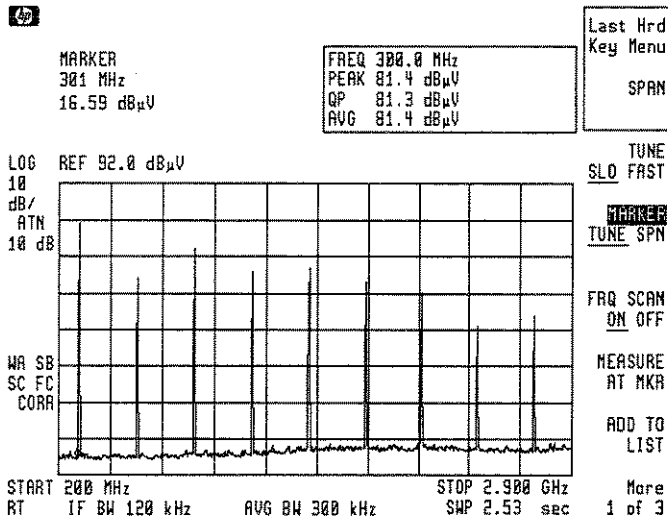

Peak, Quasi-Peak, and Average Detectors Measurement Results

- After the measurement is complete, the results are displayed in the marker display area, and the signal can now be added to a signal list by pressing:

ADD TO LIST

- Step to the first harmonic signal, take a measurement, and add this result to the signal list by using the following sequence:

⏏ (positions marker on first harmonic signal)

MEASURE AT MKR (wait for results to be displayed)

ADD TO LIST

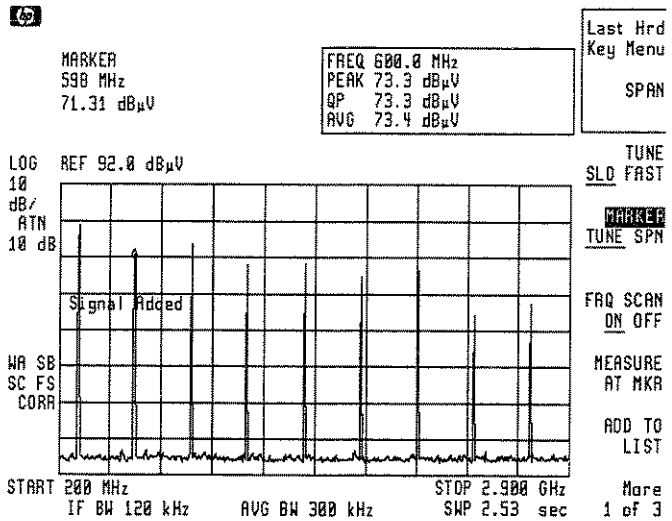

Signal Added to Signal List

Note

You may need to press the \uparrow (step up) key more than once to place the marker on the peak of the signal.

- Repeat step 7 for the remaining harmonic signals until all signals have been measured and added to the signal list.

Viewing the Signal List

- Display the signal list that was created by the 300 MHz calibrator signal and its harmonics measured above by pressing:

More 1 of 3

SIG LIST ON OFF ON (displays the signal list)

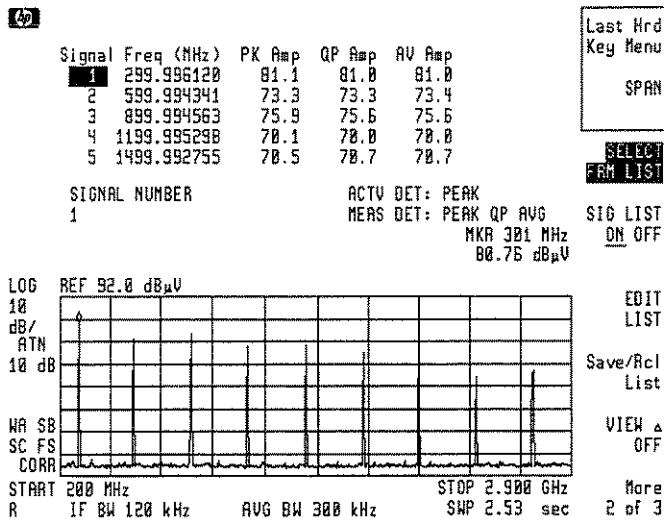

Signal List of 300 MHz Calibrator Signal and Harmonics

Sorting the Signal List 10. Sort the signal list by peak amplitude by pressing:

```

EDIT LIST
Sort Signals
SORT BY PK AMP
  
```

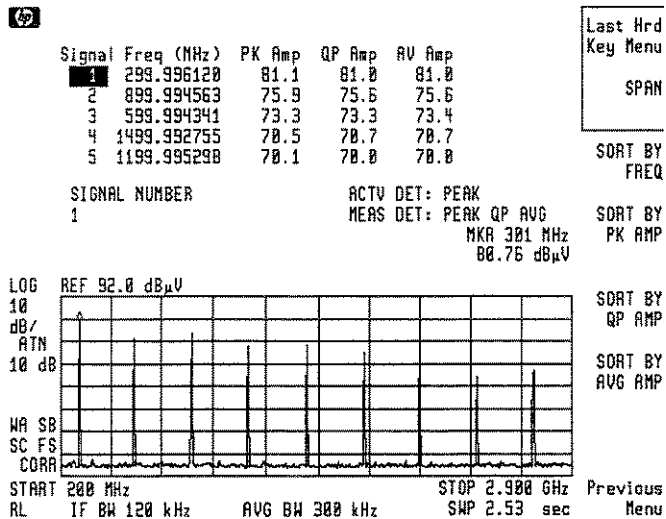

Signal List Sorted by Peak Amplitude

11. Resort the signal list by frequency by pressing:

```

SORT BY FREQ
  
```

Deleting Signals From the List

12. Delete the last harmonic signal from the signal list by using the following key sequence:

Previous Menu (returns to the editing menu)

Delete Signals (enters delete signals menu)

SELECT FRM LIST 9 **ENTER**

DELETE SIGNAL, **DELETE SIGNAL**

Note

After pressing **DELETE SIGNAL** once, the message "If you are sure, press key again to delete signal." will appear. Pressing **DELETE SIGNAL** a second time deletes the data.

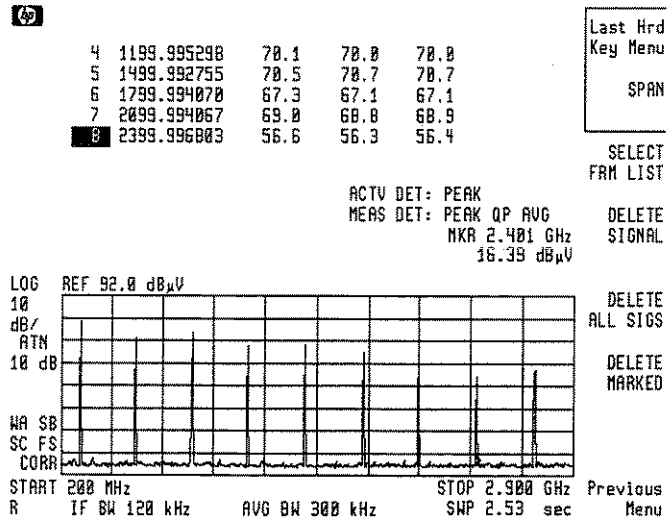

Last Harmonic Signal Deleted

13. Notice that after the signal has been deleted, the marker and signal number are decreased by one. In order to add the last harmonic signal back to the signal list, use the following key sequence:

TEST

MARKER TUNE SPN TUNE (activates marker)

↑ (positions marker on last harmonic signal)

MEASURE AT MKR (wait for results)

ADD TO LIST



5	1499.992755	70.5	70.7	70.7
6	1799.994070	67.3	67.1	67.1
7	2099.994067	69.0	68.0	68.9
8	2399.996003	56.6	56.3	56.4
9	2699.994285	59.6	59.5	59.5

Last Hrd
Key Menu

SPAN

TUNE
SLD FAST

WARNER
TUNE SPN

MARKER
2.690 GHz
59.15 dB μ V

FREQ 2.700 GHz
PEAK 59.6 dB μ V
QP 59.5 dB μ V
AVG 59.5 dB μ V

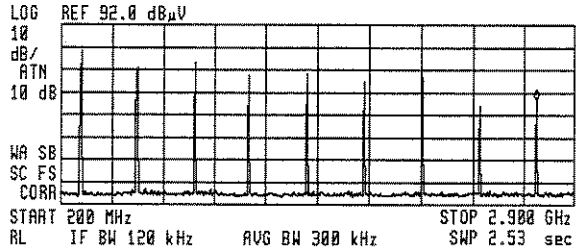

FRQ SCAN
ON OFF

MEASURE
AT MKR

ADD TO
LIST

More
1 of 3

Last Harmonic Signal Remeasured and Added to List

Marking Signals 14. Mark the 2nd harmonic signal for deletion by pressing:

More 1 of 3

EDIT LIST

Signal Marking

Enter signal number 2 and press **ENTER**

MARK SIGNAL



Signal	Freq (MHz)	PK Amp	QP Amp	AV Amp
1	299.996120	81.1	81.0	81.0
2	599.994341	73.3	73.3	73.4
3	899.994563	75.9	75.6	75.6
4	1199.995298	70.1	70.0	70.0
5	1499.992755	70.5	70.7	70.7

Last Hrd
Key Menu

SPAN

MARK
SIGNAL

SIGNAL NUMBER
2

ACTV DET: PEAK
MEAS DET: PEAK QP AVG
MKR 598 MHz
73.25 dB μ V

CLEAR
MARK

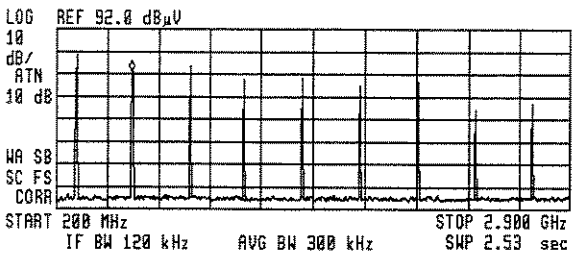

MARK ALL
SIGNALS

CLR ALL
MARKS

Select
Mark

Previous
Menu

Signal Marking

Notice that signal 2 in the list is highlighted and marked with an asterisk.

- Enter each of the 4th, 6th, and 8th harmonic signal numbers and mark them by using the following sequence:

Enter signal number, press **ENTER**

MARK SIGNAL

- Delete the marked signals by pressing:

Previous Menu

Delete Signals

DELETE MARKED, DELETE MARKED

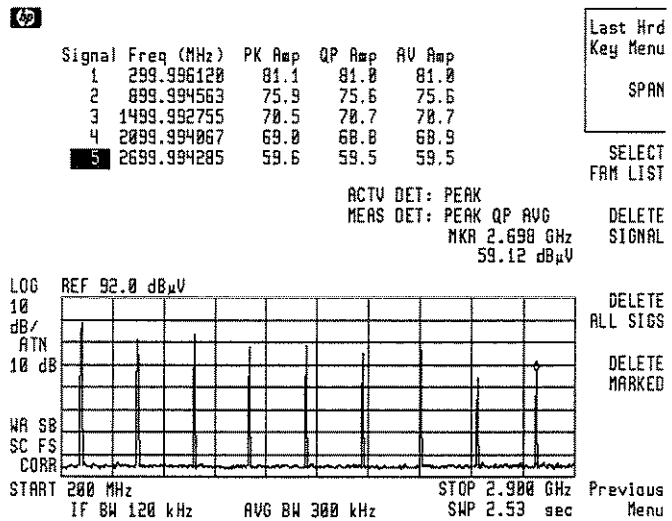

Marked Signals Deleted and List Reordered

Notice that remaining signals are renumbered sequentially.

Remeasuring Signals

- Remeasure the remaining signals on the list by pressing:

Previous Menu

Re-measure

REMEAS ALL SIGS

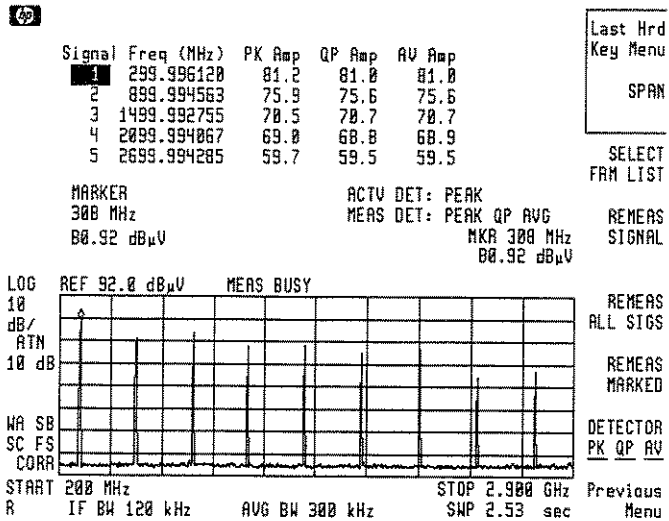

Remaining Signals in List Remeasured

Saving Signal Lists

CAUTION

When saving internal data and signal lists are displayed, disk warning messages do *not* appear. Therefore it is recommended that you verify that a file has been saved before clearing the data from your display.

For example, before saving signal list data, make sure that your disk is *not* write protected. To verify that the file was saved, press **RECALL LIST** to catalog signal lists that have been saved to the disk, then check that the correct file was saved by inspecting the file name, date, and time stamp.

18. To save the current signal list, press:

TEST

More 1 of 3

Save/Rcl List

SAVE LIST

Enter register number 5 and press **ENTER**

Note

Signal lists and associated annotation can only be saved to a disk. Refer to Chapter 11 for more information of saving and recalling. Refer to "Entering Data Using the External Keyboard" in Chapter 12 for information on the annotation editor.

Recalling Signal Lists

19. To recall the previously saved signal list from the disk, press:

RECALL LIST

A catalog of the disk fills the screen.

20. Select the filename corresponding to register number 5 using the knob or step keys, then press:

LOAD FILE

The signals in the file will be added to the end of the current signal list which remains unchanged. Any annotation for the signal list created using an external keyboard is also loaded from the file; any existing annotation is replaced.

Graphing Signal Lists

21. To show a linear graphical representation of the signals in the signal list, press:

SAVE LIN GRAPH

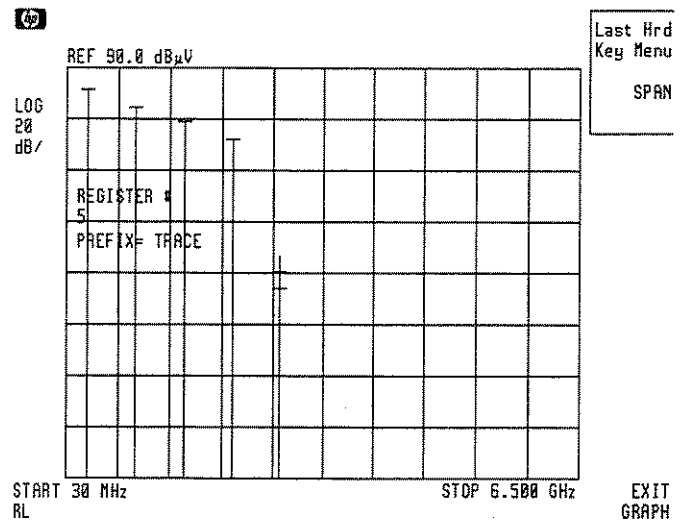

Signals Plotted on Linear Frequency Scale

22. To show a logarithmic graphical representation of the signals in the signal list, press:

SAVE LOG GRAPH

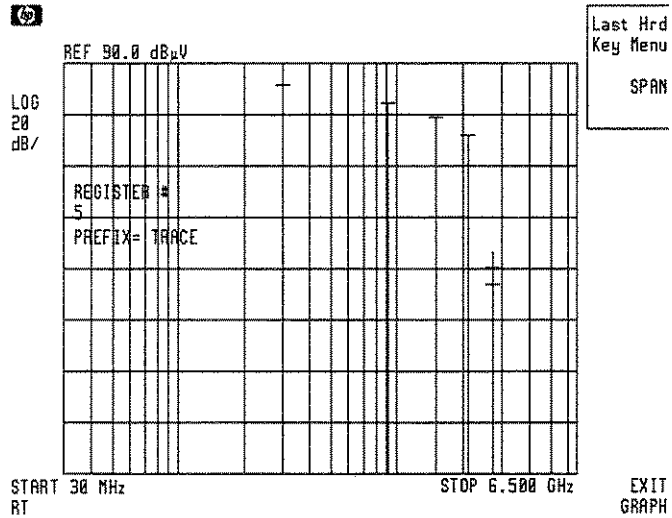

Signals Plotted on Log Frequency Scale

Saving Signal Lists Graphs

Note

Signal list graphs can only be saved to a disk.

23. To save the displayed log signal list graph to a floppy disk:

Enter the register number 8 and press **ENTER**

The saving process takes several minutes. The file on disk is a Windows bitmap (.BMP) accepted by most Windows applications which read graphic images.

Note

The "Register #" message is not saved to the .BMP file.

Stepped Measurements

Stepped measurements allow the receiver to step across the frequency band in predefined frequency steps. When making the measurement, the receiver steps to a given frequency in a fixed-tuned fashion. You can:

- Define the frequency step as either linear or logarithmic.
 - Specify the step size for each type of step.
 - Specify which detector(s) to measure.
 - Specify the dwell time for each detector.
-

Performing a Stepped Measurement

1. Preset the receiver to a known state by pressing:

PRESET

2. Display the 300 MHz calibrator signal and its harmonics by pressing:

INPUT

VIEW CAL ON OFF ON

3. To perform a stepped measurement with a center frequency of 300 MHz and a span of 3 MHz, press:

FREQUENCY

CENTER FREQUENCY 300 **MHz**

SPAN 3 **MHz**

AMPLITUDE

↓ (moves the signal trace to the top of the display)

TEST

More 1 of 3

More 2 of 3

MEAS STEPPED

Note

To ensure all signals are captured and their amplitudes accurately displayed, the linear step size should be no more than one-half of a bandwidth.

When the receiver completes the stepped measurement, three traces are displayed as shown below.

Note

When using the receiver RF section by itself, refer to “Receiver RF Section Annotation” in Chapter 1 of this manual.

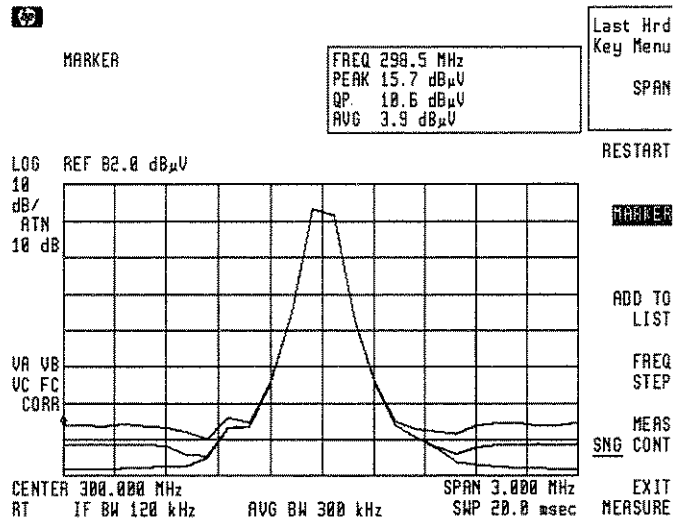

Stepped Measurement Display

The traces are displayed as follows:

- Yellow Peak detector amplitude
- Blue Quasi-peak detector amplitude
- Magenta Average detector amplitude

4. When the measurements are complete, press:

EXIT MEASURE

Note

When EXIT MEASURE is pressed, the measurement is stopped and all data is lost. Be sure to save the data by adding it to the signal list table *prior* to pressing EXIT MEASURE.

Selecting a Detector and Setting a Dwell Time

At each frequency step, you can select a detector and a dwell time for the detector.

- To select the peak and quasi-peak detector and set a dwell time of two seconds, press:

```

SETUP
More 1 of 3
Inst Setup
Measure Detector
DETECTOR PK QP AV PK
DETECTOR PK QP AV PK QP
QP DWELL TIME .....2 sec
    
```

- To view an onscreen display of the signal list and make a stepped measurement, press:

```

TEST
More 1 of 3
SIG LIST ON OFF ON
More 2 of 3
MEAS STEPPED
    
```

When the measurement is completed, the marker is positioned at the left edge of the screen. The marker box displays the information on the selected detectors.

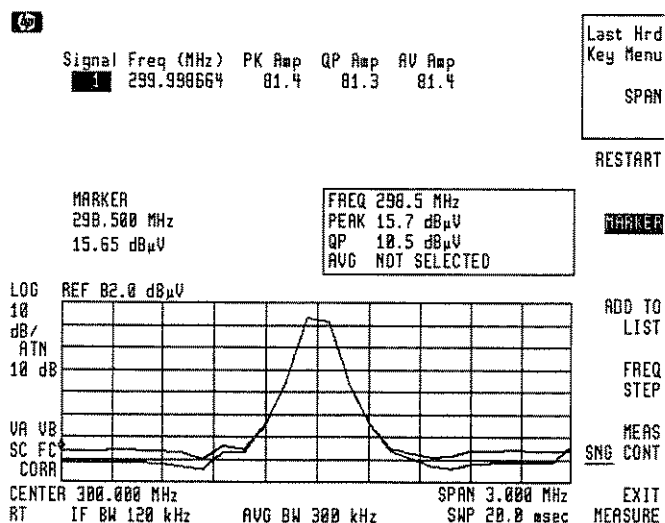

Stepped Measurement Using Two Detectors

Using the Marker

The marker can be used to read the frequency and amplitude of two detectors, for example, peak and quasi-peak. When the measurement is complete the marker function is the active function. Use the keypad, step keys or knob to move the marker along the trace. The frequency and amplitude values of the two traces at the marker are displayed in the marker box.

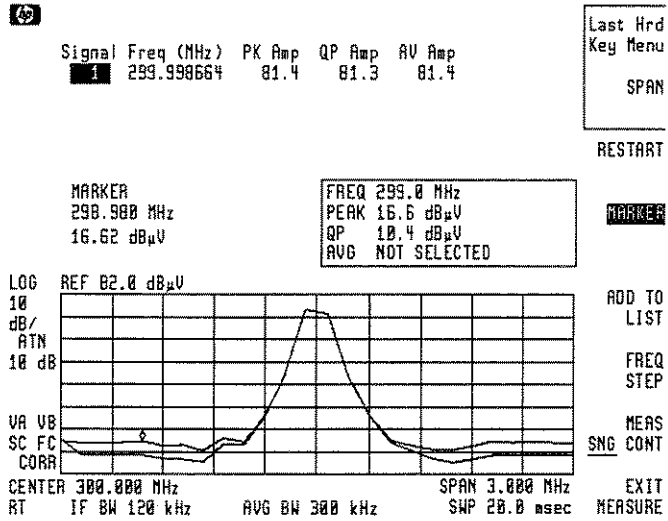

Adding Data to the Signal List Table

The results of the stepped measurement can be added to the signal list table. See Chapter 4 for more information on the signal list table.

If you wish to add the results of the stepped measurement to the signal list table, press:

ADD TO LIST

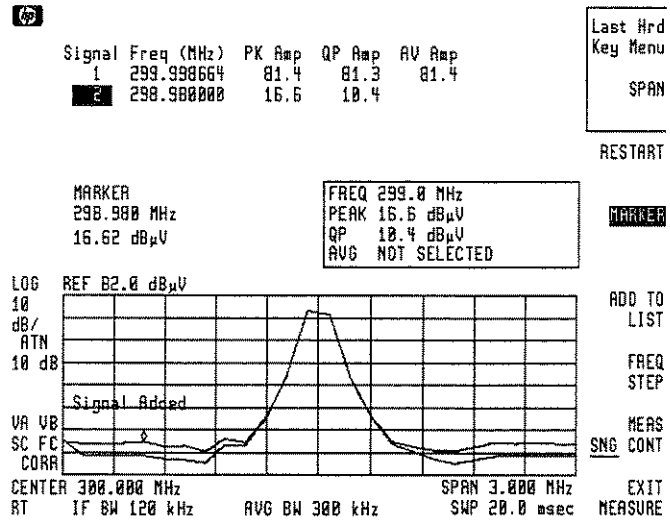

Data Added to the Signal List Table

The new data now appears in the signal list.

Changing the Frequency Step

The default step size is equal to one IF bandwidth. To change the default step size, press:

FREQ STEP 0.5 **(ENTER)**

Restarting and Stopping the Measurement

To start and stop a stepped measurement:

1. Start the measurement by pressing:

RESTART

2. When the measurement reaches 300.2 MHz, press:

STOP

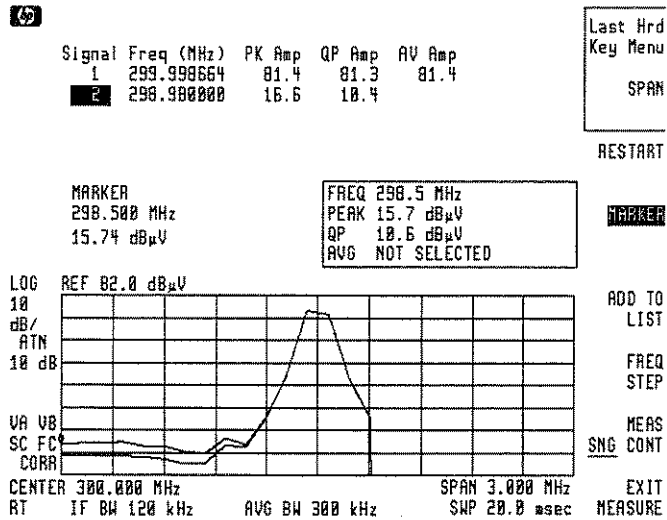

Stepped Measurement Stopped at 300.2 MHz

Note

If the measurement is stopped before the trace is completed, the marker may be used only on the portion of the trace recorded *before* the measurement was stopped.

- Use the knob to move the marker along the trace. Observe the portion of the trace over which the marker is active.
- To select a continuous step mode, press:

MEAS SNG CONT CONT

- To restart the measurement, press:

RESTART

Note

The MEAS SNG CONT function is always active. Executing the function during a measurement will not corrupt the measurement.

- When the measurements are complete, press:

EXIT MEASURE

Note

When EXIT MEASURE is pressed the measurement is stopped and all data is lost. Be sure to save the data by adding it to the signal list table *prior* to pressing EXIT MEASURE.

Using Logarithmic and Linear Steps

During conducted measurements, (for example, CISPR bands A and B), the emissions are usually broadband in nature and you may wish to use the logarithmic frequency step function. This function can be used whenever a logarithmic display, spanning several decades, would be more informative than a linear display. The following figures show the two display options.

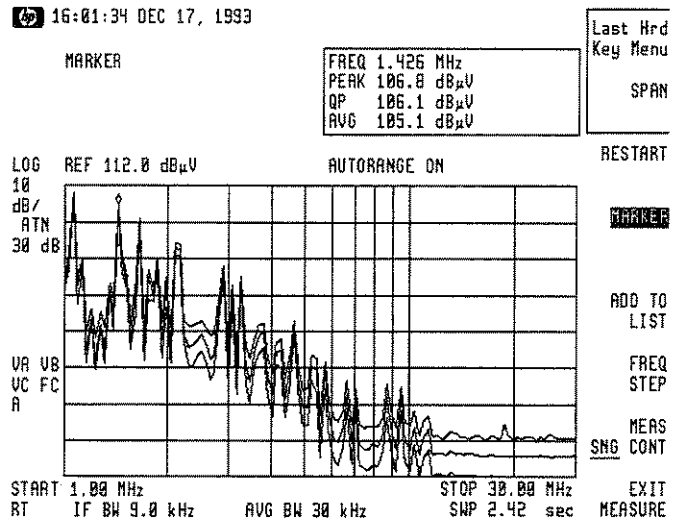

Using a Logarithmic Step Size

Note

When using a logarithmic step size, the frequency step is specified as a percentage of frequency. The default step size equals three percent.

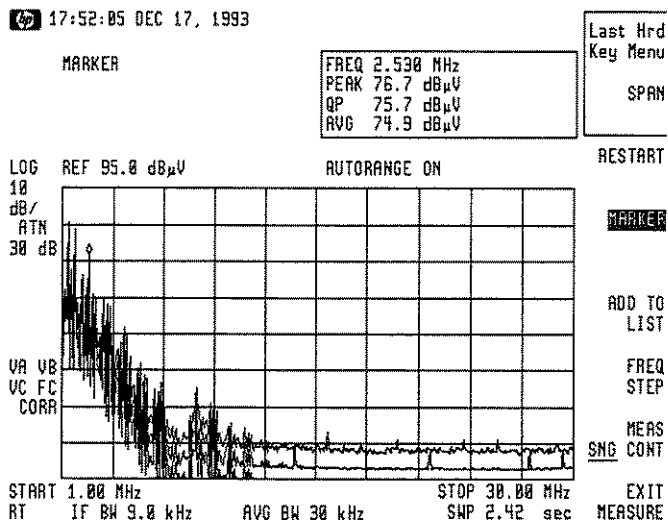

Using a Linear Step Size

Making EMI Diagnostic Measurements

What You'll Learn in This Chapter

This chapter demonstrates how to make diagnostic measurements using the EMI receiver and the receiver RF section. Each measurement focuses on different functions. The measurement procedures covered in this chapter are:

- Resolving signals of equal amplitude using the IF bandwidth function.
- Resolving small signals hidden by large signals using the IF bandwidth function.
- Increasing the frequency readout resolution using the marker counter.
- Decreasing the frequency span using the marker track function.
- Peaking signal amplitude using the preselector peak function.
- Tracking unstable signals using marker track and the maximum hold and minimum hold functions.
- Comparing signals using delta markers.
- Measuring low-level signals using attenuation, averaging bandwidth, and video averaging.
- Identifying distortion products using the RF attenuator and traces.
- Measuring signals near band boundaries using harmonic lock.

Resolving Signals of Equal Amplitude

In responding to a continuous-wave signal, a scanning receiver traces out the shape of its intermediate frequency (IF) filter. As we change the filter bandwidth, we change the width of the displayed response. If a wide filter is used and two equal-amplitude input signals are close enough in frequency, then the two signals appear as one. Thus, signal resolution is determined by the IF filters inside the receiver.

For maximum flexibility, the receiver allows you to select from the CISPR 200 Hz, 9 kHz and 120 kHz 6 dB measurement IF bandwidths, or from the 30 Hz to 3 MHz 3 dB diagnostic IF bandwidth in a 1, 3, 10 sequence, plus 5 MHz. The 1 MHz to 5 MHz. The 1 MHz bandwidth maybe a 6 dB bandwidth. The bandwidths tell us how close together equal amplitude signals can be and still be distinguished from each other. The IFBW function selects the IF filter setting.

Generally, to resolve two signals of equal amplitude, the IF bandwidth must be less than or equal to the frequency separation of the two signals. If the bandwidth is equal to the separation, a dip of approximately 3 dB is seen between the peaks of the two equal signals, and it is clear that more than one signal is present. See Figure 6-2.

In order to keep the receiver calibrated, sweep time is automatically set to a value that is inversely proportional to the square of the IF bandwidth. So, if the IF bandwidth is reduced by a factor of 10, the sweep time is increased by a factor of 100 when sweep time and bandwidth settings are coupled. (Sweep time is proportional to $1/BW^2$.) For fastest measurement times, use the widest IF bandwidth that still permits discrimination of all desired signals.

In this example you will resolve two signals of equal amplitude with a frequency separation of 100 kHz.

1. Obtain two signals with a 100 kHz separation by connecting two signal sources to the receiver input as shown in Figure 6-1.

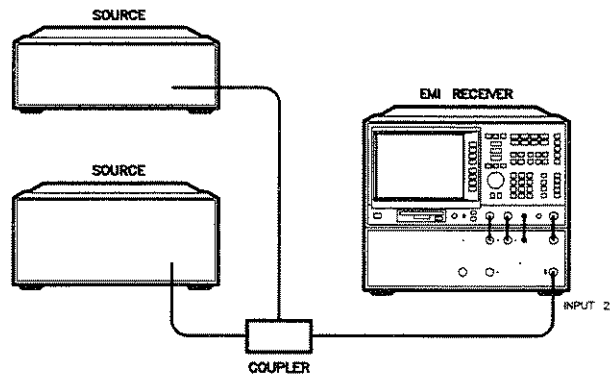

Figure 6-1. Set-Up for Obtaining Two Signals

2. Set the frequencies of the two sources to be 100 kHz apart, for example, 300 MHz and 300.1 MHz. The amplitude of both signals should be approximately 87 dB μ V (-20 dBm).
3. Set the receiver to a known state by pressing:

```

PRESET
FREQUENCY
CENTER FREQ ..... 300 MHz
SPAN ..... 2 MHz
AMPLITUDE
REF LVL ..... 82 +dB $\mu$ V
  
```

A single signal peak is visible.

4. Since the IF bandwidth must be less than or equal to the frequency separation of the two signals, an IF bandwidth of 30 kHz or less must be used to resolve the two input signals. Change the IF bandwidth to 10 kHz by pressing:

```

BW
IF BW AUTO MAN ..... 10 kHz
  
```

The display should be similar to that shown in Figure 6-2. To resolve the signals further, use the knob or step keys to reduce the IF bandwidth.

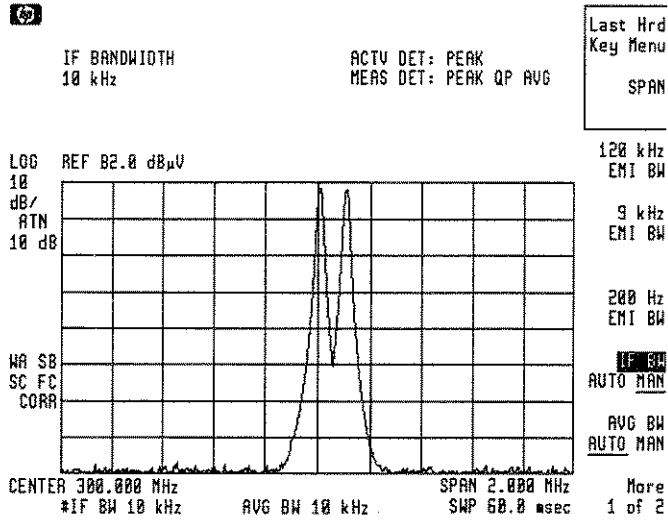

Figure 6-2. Resolving Signals of Equal Amplitude

As the IF bandwidth is decreased, resolution of the individual signals is improved and the sweep time is increased. For fastest measurement times, use the widest possible resolution bandwidth.

Since the IF bandwidth has been changed from the coupled value, a "#" mark appears next to "IF BW" in the lower-left corner of the screen, indicating that the IF bandwidth is uncoupled.

Resolving Small Signals Hidden by Large Signals

When attempting to resolve signals that are not equal in amplitude, you must consider the shape of the IF filter as well as its 3 dB or 6 dB bandwidth. The shape of the measurement filters is defined by CISPR 16. The shape of the diagnostic filter is defined by the shape factor, which is the ratio of the 60 dB bandwidth to the 3 dB bandwidth. (Generally, the IF filters in this receiver have shape factors of 15:1 or less.) If a small signal is too close to a larger signal, the smaller signal can be hidden by the skirt of the larger signal. To view the smaller signal, you must select an IF bandwidth such that k is less than a . See Figure 6-3.

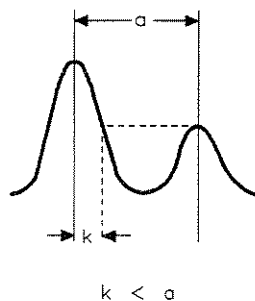

smallfig

Figure 6-3. IF Bandwidth for Resolving Small Signals

The separation between the two signals must be greater than half the filter width of the larger signal at the amplitude level of the smaller signal.

The following example resolves two input signals with a frequency separation of 100 kHz and an amplitude difference of 50 dB.

1. Obtain two signals with a 100 kHz separation by connecting the equipment as shown in the previous section, "Resolving Signals of Equal Amplitude".
2. Set the receiver to a known state by pressing:

```

PRESET
FREQUENCY
CENTER FREQ ..... 300 MHz
SPAN ..... 2 MHz
    
```

3. Set the IF bandwidth to 30 kHz by pressing:

BW
IF BW AUTO MAN 30 kHz

4. Set one source to a frequency of 300 MHz and an amplitude of 87 dB μ V (-20 dBm).

5. Set the second source to a frequency of 300.1 MHz and an amplitude of 37 dB μ V (-70 dBm).

6. Set the 300 MHz signal to the reference level by pressing:

PEAK SEARCH
MKR →
MARKER → REF LVL

If a 30 kHz filter is used, the 60 dB bandwidth will be 450 kHz. Since the half-bandwidth (225 kHz) is wider than the frequency separation, the signals will not be resolved. See Figure 6-4. (To determine resolution capability for intermediate values of amplitude level differences, consider the filter skirts between the 3 dB and 60 dB points to be approximately straight. In this case, we simply used the 60 dB value.)

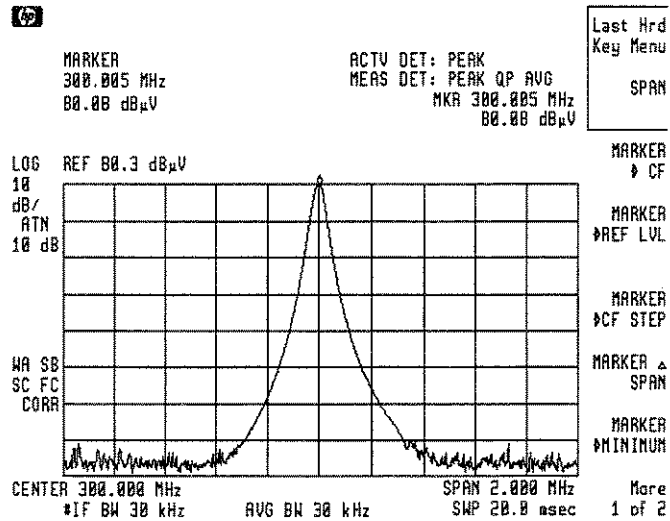

Figure 6-4. Signal Resolution with a 30 kHz IF Bandwidth

7. To resolve the two signals reduce the IF bandwidth by pressing:

BW

IF BW AUTO MAN 10 **kHz**

If a 10 kHz filter with a typical shape factor of 15:1 is used, the filter will have a bandwidth of 150 kHz at the 60 dB point. The half-bandwidth (75 kHz) is narrower than the frequency separation, so the input signals will be resolved.

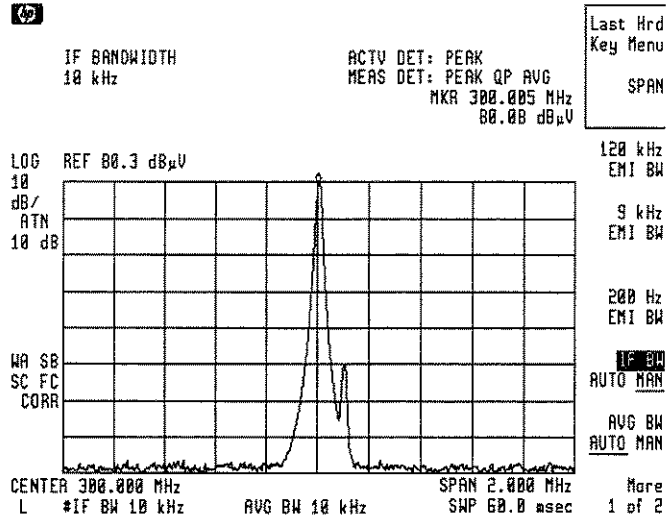

Figure 6-5. Signal Resolution with a 10 kHz IF Bandwidth

Increasing the Frequency Readout Resolution

The marker counter increases the resolution and accuracy of frequency readout. When using the marker count function, if the bandwidth to span ratio is too small (less than 0.01), the Reduce Span message appears on the display. If Widen RES BW is displayed, it indicates that the resolution bandwidth is too narrow. If there is another, larger signal (even off the display), the count will be for the larger signal.

The following example increases the resolution and accuracy of the frequency readout on the signal of interest.

1. Set the receiver to a known state by pressing:

```
PRESET
INPUT
VIEW CAL ON OFF ON
FREQUENCY
CENTER FREQ ..... 300 MHz
SPAN ..... 3 MHz
```

2. Place a marker on the signal of interest by pressing:

```
PEAK SEARCH
MKR →
```

3. Turn the marker counter on by pressing:

```
MARKER FUNCTION
MK COUNT ON OFF ON
```

The message COUNTER will be displayed as well as the frequency and amplitude of the marker.

4. Increase the counter resolution by pressing:

More 1 of 2

CNT RES AUTO MAN 1 kHz

The marker counter readout is displayed in the upper-right corner of the screen. The resolution can be set from 1 Hz to 100 kHz.

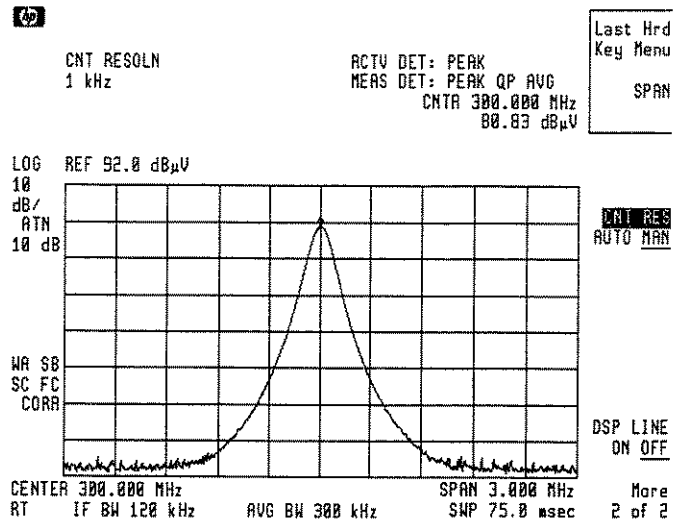

Figure 6-6. Using the Marker Counter

5. The marker counter remains on until turned off. Turn off the marker counter by pressing:

MARKER FUNCTION

MK COUNT ON OFF OFF

OR

MKR

MKR 1 ON OFF OFF

Decreasing the Frequency Span

Using the marker track function, you can quickly decrease the span while keeping the signal at center frequency.

This example examines a carrier signal in a 200 kHz span.

1. Set the receiver to a known state by pressing:

```

PRESET
INPUT
VIEW CAL ON OFF ON
FREQUENCY
STOP ..... 700 MHz
PEAK SEARCH
    
```

2. Move the signal to the center of the screen by pressing:

```

MARKER FUNCTION
MK TRACK ON OFF ON
    
```

Because the marker track function automatically maintains the signal at the center of the screen, you can reduce the span quickly for a closer look. If the signal drifts off of the screen as you decrease the span, use a wider frequency span.

3. Decrease the span by pressing:

```

SPAN ..... 2 MHz
    
```

The span decreases in steps as automatic zoom is completed. See Figure 6-7. You can also use the knob or step keys to decrease the span.

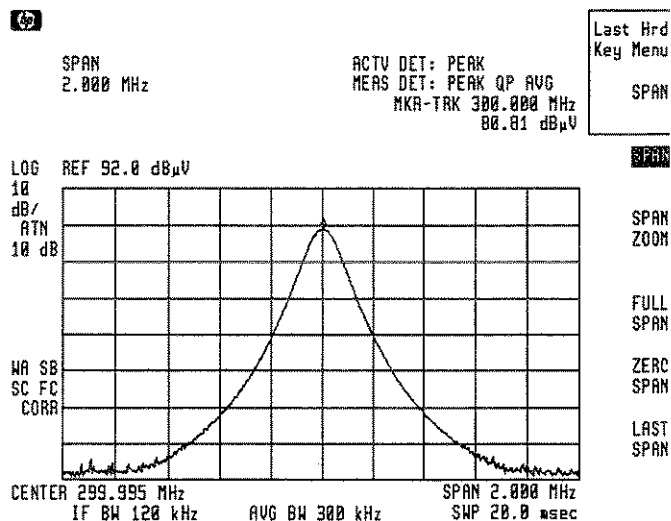

Figure 6-7. After Zooming In on the Signal

4. Turn off the marker track function by pressing:

```

MARKER FUNCTION
MK TRACK ON OFF OFF
    
```

Peaking Signal Amplitude with Preselector Peak

For an HP 8546A/HP 85462A only.

Note

PRESEL PEAK works only *above* 2.9 GHz.

The preselector peak function automatically adjusts the input filter tracking above 2.9 GHz to peak the signal at the active marker. Using preselector peak prior to measuring a signal yields the most accurate amplitude reading at the specified frequency. To maximize the peak response of the high frequency input filter and adjust the tracking, tune the marker to a signal and press:

AMPLITUDE

PRESEL PEAK

Note

PRESEL PEAK maximizes the peak response of the signal of interest, but may degrade the frequency response at other frequencies. Use **PRESEL DEFAULT** or **PRESET** to clear preselector-peak values before measuring a signal at another frequency.

PRESEL DEFAULT provides the best flatness for a full single-band and for viewing several signals simultaneously.

1. Set the receiver to a known state by pressing:

PRESET

INPUT

INPUT 2 1-6.5G

VIEW CAL ON OFF ON

FREQUENCY

START 3.0 **GHz**

STOP 3.5 **GHz**

PREAMP OFF (Toggles on and off.)

PEAK SEARCH

2. Peak the amplitude response by pressing:

AMPLITUDE
PreSel Peak

The message peaking is displayed while the routine is working.

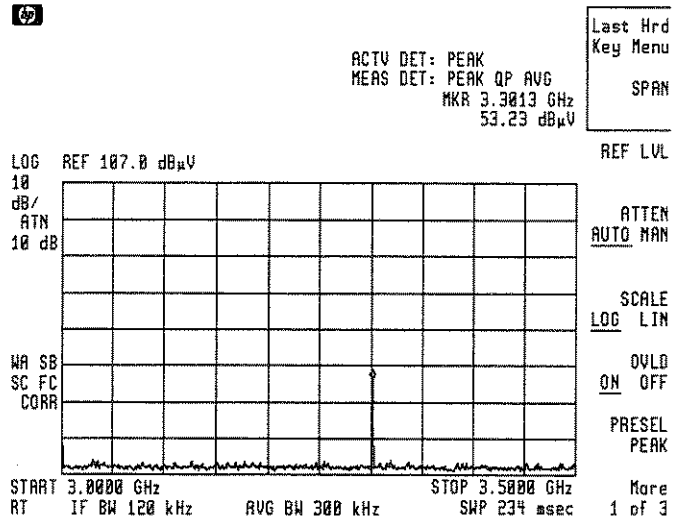

Figure 6-8. Peaking Signal Amplitude Using Preselector Peak

Tracking Unstable Signals

The marker track function is useful for tracking unstable signals that drift with time. The maximum hold and minimum hold functions are useful for displaying modulated signals which appear unstable, but have an envelope that contains the information-bearing portion of the signal. **MK TRACK ON OFF** may be used to track these unstable signals. Use **PEAK SEARCH** to place a marker on the highest signal on the display. Pressing **MK TRACK ON OFF ON** will

bring that signal to the center frequency of the graticule and adjust the center frequency every sweep to bring the selected signal back to the center. **SPAN ZOOM** is a quick way to perform the **PEAK SEARCH**, **MARKER FUNCTION**, **MK TRACK ON OFF**, **SPAN** key sequence.

Note the primary function of the marker track function is to track unstable signals, not to track a signal as the center frequency of the receiver is changed. If you choose to use the marker track function when changing center frequency, check to ensure the signal found by the tracking function is the correct signal.

Using the Marker Track Function

In this example you will use the marker track function to keep a drifting signal in the center of the display and monitor its change.

This example requires a modulated signal. An acceptable signal can be easily found by connecting an antenna to the receiver input and tuning to the FM broadcast band (88 to 108 MHz).

1. Connect an antenna to the receiver input.
2. Set the analyzer to a known state by pressing:

```
PRESET
FREQUENCY
CENTER FREQ ..... 104.9 MHz
SPAN ..... 20 MHz
BW
IF BW AUTO MAN ..... 30 kHz
```

Note

Use a different signal frequency if no FM signal is available at 104.9 MHz in your area.

3. Adjust the reference level so the signal is within two divisions of the top of the display by pressing:

```
AMPLITUDE
REF LVL
```

Adjust the reference level so the signal is within two divisions of the top of the display.

4. Turn autoranging on by pressing:

```
AUTORANGE
```

5. Set the span by pressing:

SPAN
SPAN ZOOM 500 **kHz**

Notice the signal has remained in the center of the display.

Note

If the signal you selected drifts too quickly for the receiver to keep up with, increase the span.

6. The signal frequency drift can be read from the screen if both the marker track and marker delta functions are active. Press:

MKR
MARKER Δ
MARKER FUNCTION
MK TRACK ON OFF ON

The marker readout indicates the change in frequency and amplitude as the signal drifts. (See Figure 6-9.)

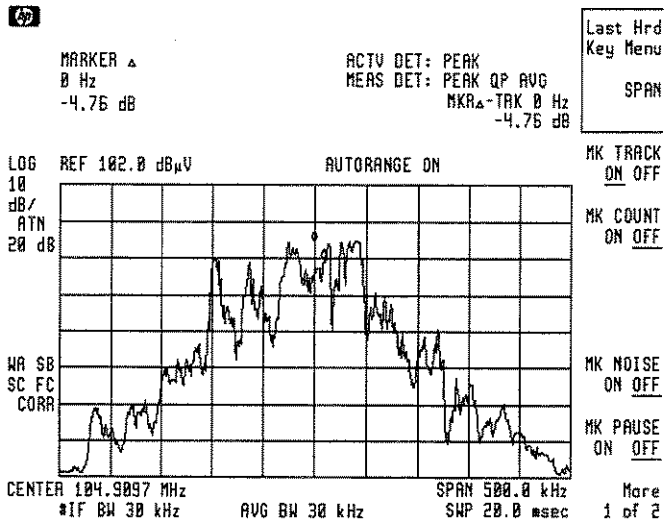

Figure 6-9. Using Marker Tracking to Track an Unstable Signal

The receiver can measure the short-term and long-term stability of a source. The maximum amplitude level and the frequency drift of an input signal trace can be displayed and held by using the maximum-hold function. The minimum amplitude level can be displayed by using minimum hold (available for trace C only).

You can use the maximum-hold and minimum-hold functions if, for example, you want to determine how much of the frequency spectrum an FM signal occupies.

Using Maximum-Hold and Minimum-Hold

In this example you will use the maximum-hold and minimum-hold functions to monitor the envelope of an FM signal.

1. Connect an antenna to the receiver input.
2. Set the receiver to a known state by pressing:

```
PRESET
FREQUENCY
CENTER FREQ ..... 100 MHz
SPAN ..... 20 MHz
AUTORANGE ON (Toggles on and off.)
BW
IF BW AUTO MAN ..... 10 kHz
```

3. Determine the signal peak by pressing:

```
PEAK SEARCH
```

Adjust the reference level (under **Amplitude**) so the signal is within two divisions of the top of the display.

4. Adjust the span by pressing:

```
SPAN
SPAN ZOOM ..... 500 kHz
```

Notice the signal has remained in the center of the display.

5. Turn off the marker track function by pressing:

```
MARKER FUNCTION
MK TRACK ON OFF OFF
```

6. Measure the excursion of the signal by pressing:

TRACE
MAX HOLD A

As the signal varies, maximum hold maintains the maximum responses of the input signal, as shown in Figure 6-10.

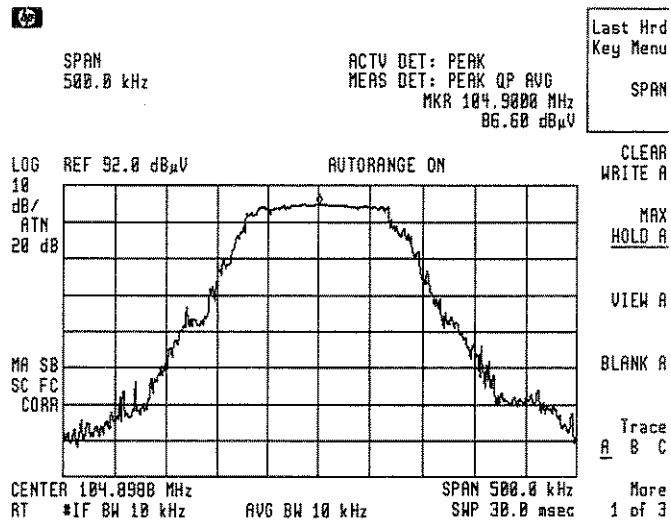

Figure 6-10. Viewing an Unstable Signal Using Max Hold A

Annotation on the left side of the screen indicates the trace mode. For example, MA SB SC indicates trace A is in maximum-hold mode, trace B and trace C are in store-blank mode.

7. Select trace B by pressing:

TRACE
TRACE A B C B

8. Place trace B in clear-write mode by pressing:

CLEAR WRITE B

Trace B displays the current measurement results as it sweeps. Trace A remains in maximum-hold mode, showing the frequency shift of the signal.

9. Select trace C by pressing:

TRACE A B C C

10. Display the minimum amplitude of the signal by pressing:

MIN HOLD C

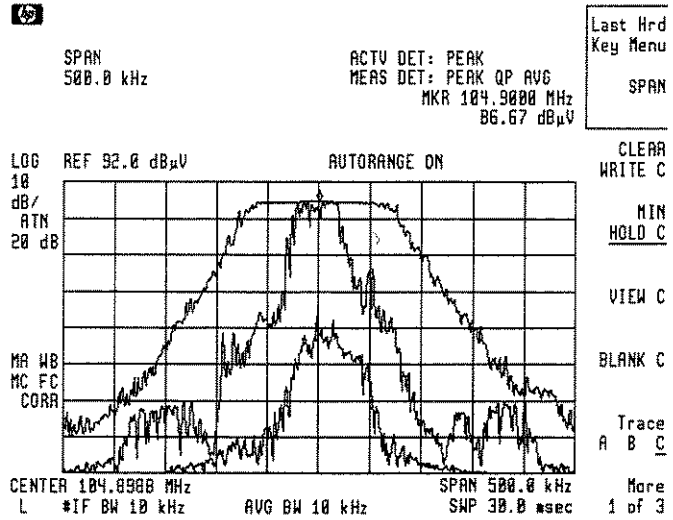

Figure 6-11. Viewing an Unstable Signal using Max and Min Hold

Comparing Signals Using Delta Markers

Using the receiver, you can easily compare frequency and amplitude differences between signals, such as radio or television signal spectra. The delta marker function lets you compare two signals when both appear on the screen at one time or when only one appears on the screen.

Measuring Differences Between Two Signals

In this example you will measure the differences between two signals on the same display screen.

1. Set the receiver to a known state by pressing:

PRESET
INPUT
VIEW CAL ON ON

The calibrator signal and its harmonics appear on the display.

2. Place a marker at the highest peak on the display by pressing:

PEAK SEARCH

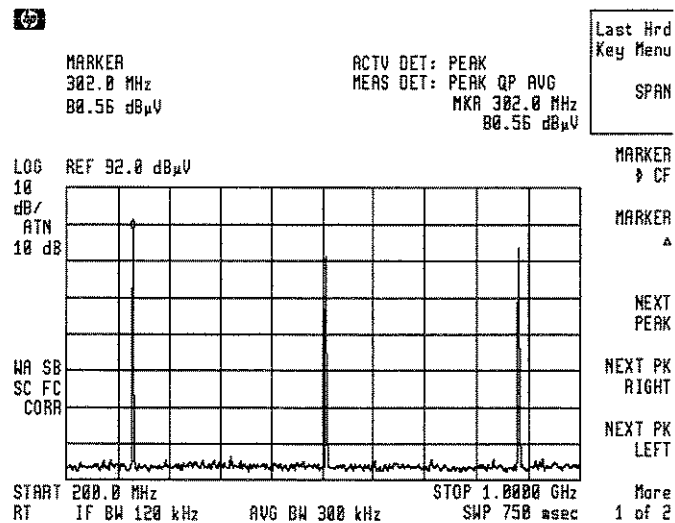

Figure 6-12. Placing a Marker on the CAL OUT Signal

3. Activate a second marker at the position of the first marker by pressing:

MARKER \blacktriangle

4. Move the second marker to another signal peak using:

NEXT PK RIGHT, **NEXT PK LEFT**, the step keys, or the knob.

5. The amplitude and frequency difference between the markers is displayed in the active function block and in the Marker Box. See Figure 6-13.

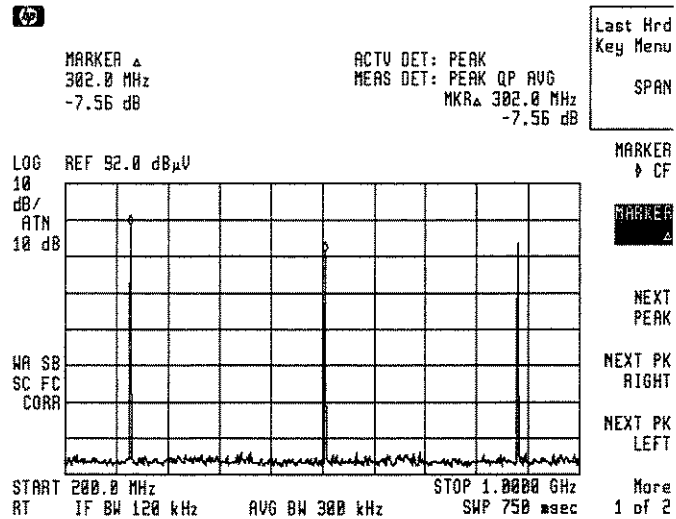

Figure 6-13. Using the Marker Delta Function

Measuring Differences Between Signals On Screen and Off Screen

In this example you will measure the frequency and amplitude difference between two signals that do not appear on the screen at the same time. (This technique is useful for harmonic distortion tests when narrow span and narrow bandwidth are necessary to measure the low-level harmonics.)

1. Set the receiver to a known state by pressing:

PRESET

INPUT

VIEW CAL ON ON

FREQUENCY

CENTER FREQ 300 **MHz**

SPAN 10 **MHz**

2. Place a marker on the peak by pressing:

PEAK SEARCH

3. Identify the position of the first marker by pressing:

MARKER Δ

4. Set the center frequency by pressing:

FREQUENCY

CENTER FREQ 600 **MHz**

The first marker remains on the screen at the amplitude of the first signal peak.

Note

Changing the reference level changes the marker delta amplitude readout.

The annotation in the upper-right corner of the screen indicates the amplitude and frequency difference between the two markers. See Figure 6-14.

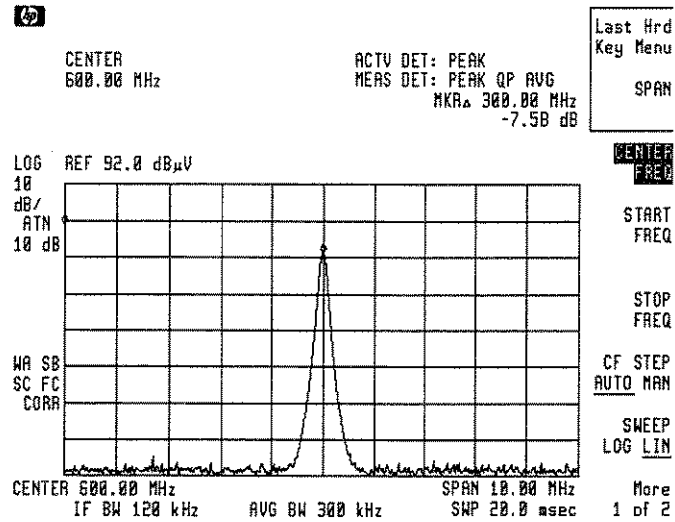

Figure 6-14. Frequency and Amplitude Differences

Turn the markers off by pressing:

MKR

More 1 of 2

MARKER ALL OFF

5. Reduce the span to 1 MHz by pressing:

SPAN

Use the step-down key (**↓**) to reduce the span. See Figure 6-16.

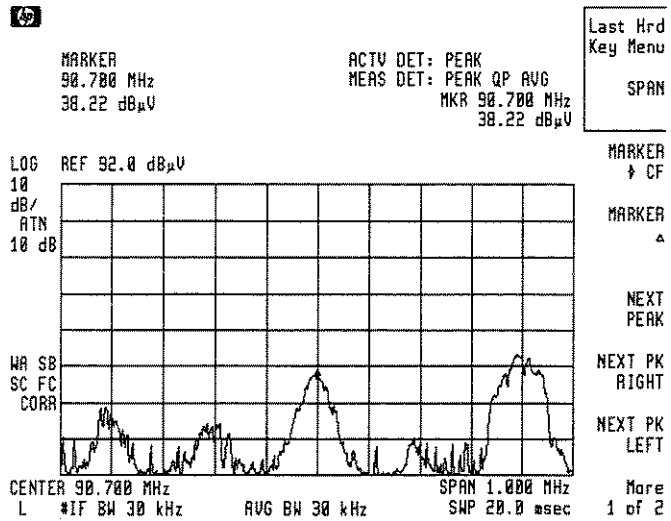

Figure 6-16. Low-Level Signal

6. Press:

AMPLITUDE

ATTEN AUTO MAN

Press the step-up key (**↑**) twice to select 30 dB attenuation. Increasing the attenuation moves the noise floor closer to the signal.

A “#” mark appears next to the ATT annotation at the side of the display, indicating the attenuation is no longer coupled to other receiver settings.

Measuring Low-Level Signals

Receiver sensitivity is the ability to measure low-level signals. It is limited by the noise generated inside the receiver. The receiver input attenuator and bandwidth settings affect the sensitivity by changing the signal-to-noise ratio. The attenuator affects the level of a signal passing through the instrument, whereas the bandwidth affects the level of internal noise without affecting the signal. In the first two examples in this section, the attenuator and bandwidth settings are adjusted to view low-level signals.

If, after adjusting the attenuation and IF bandwidth, a signal is still near the noise, visibility can be improved by using the averaging-bandwidth and video-averaging functions, as demonstrated in the following examples.

Reducing Input Attenuation

If a signal is very close to the noise floor, reducing input attenuation brings the signal out of the noise. In this example, reducing the attenuation to 0 dB maximizes signal power in the receiver.

Note

The total power of all input signals at the receiver input must not exceed the maximum power level for the receiver.

1. Connect an antenna to the receiver input, then press:

PRESET

2. Reduce the frequency range to view a low-level signal of interest. For example, to reduce the frequency span to 20 MHz press:

FREQUENCY

START FREQ 88 **MHz**

STOP FREQ 108 **MHz**

BW

IF BW AUTO MAN 30 **kHz**

3. Place a marker on the low-level signal of interest by pressing:

MKR

Use the knob to position the marker at the signal's peak.

4. Place the signal at center frequency by pressing:

MKR →

MARKER → CF

Reducing IF Bandwidth

In this example the IF bandwidth will be reduced to view low-level signals.

1. As in the previous example, connect an antenna to the receiver input. Set the receiver to view a low-level signal.
2. Press:

BW
IF BW AUTO MAN 10 **kHz**

The low-level signal appears more clearly because the noise level is reduced. Refer to Figure 6-18.

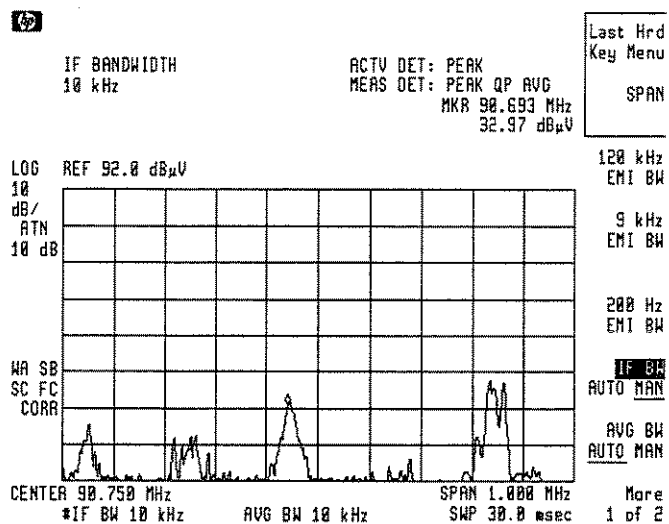

Figure 6-18. Decreasing IF bandwidth

A “#” mark appears next to the RES BW annotation at the lower-left corner of the screen, indicating the resolution bandwidth is uncoupled.

As the IF bandwidth is reduced, the sweep time is increased to maintain receiver calibration.

Reducing Averaging Bandwidth

In this example you will use the averaging filter control to observe low-level narrow-band signals close to the noise floor. The averaging filter is a post-detection low-pass filter that smooths the displayed trace. When signal responses near the noise level of the receiver are visually masked by the noise, the averaging filter can be narrowed to smooth this noise and improve the visibility of the signal. (Reducing averaging bandwidth requires a slower sweep time to keep the receiver calibrated.)

Using the averaging-bandwidth function, measure the amplitude of a low-level signal.

1. As in the previous examples, connect an antenna to the receiver input. Set the receiver to view a low-level signal.
2. Reduce the IF bandwidth by pressing:

BW
IF BW AUTO MAN 30 **kHz**

3. Reduce the averaging bandwidth by pressing:

AVG BW AUTO MAN 100 **Hz**

This improves the display of the signal by smoothing the noise, allowing better measurement of the signal amplitude.

A “#” mark appears next to the AVG BW annotation at the bottom of the screen, indicating that the averaging bandwidth is not coupled to the IF bandwidth.

Instrument preset conditions couple the averaging bandwidth to the IF bandwidth so that the averaging bandwidth is equal to or wider than the IF bandwidth. If the averaging bandwidth is uncoupled when averaging bandwidth is the active function, pressing **AVG BW AUTO MAN** AUTO recouples the averaging bandwidth. Refer to Figure 6-19.

Note Narrow averaging bandwidths mask pulse noise levels.

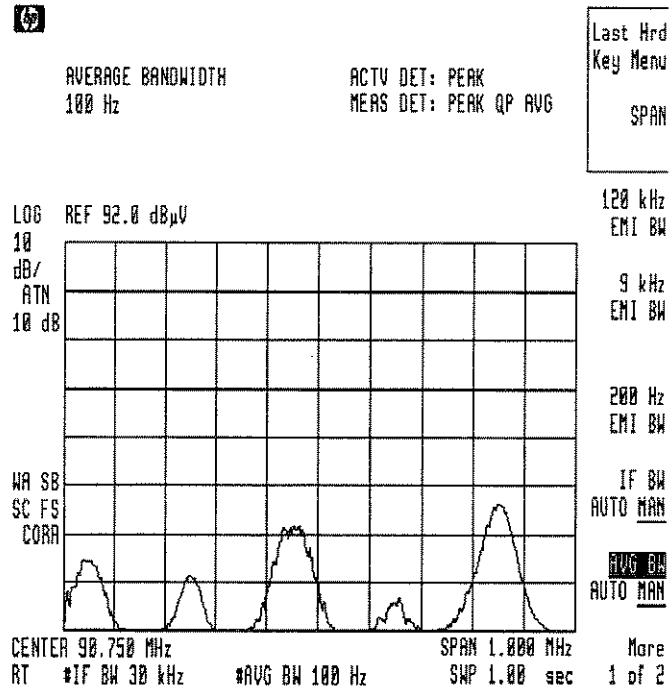

Figure 6-19. Decreasing Averaging Bandwidth

Using Video Averaging

In this example a signal level very close to the noise floor will be made more visible using video averaging.

Video averaging is a digital process in which each trace point is averaged with the previous trace-point average. Selecting video averaging changes the detection mode from peak to sample. The result is a sudden drop in the displayed noise level. The sample mode displays the instantaneous value of the signal at the end of the time or frequency interval represented by each display point, rather than the value of the peak during the interval. Sample mode is not used to measure signal amplitudes accurately because it may not find the true peak of the signal.

Note

The time required to construct a full trace that is averaged to the desired degree is approximately the same when using either the averaging-bandwidth or the video-averaging technique. The averaging-bandwidth technique completes the averaging as a slow sweep is taken, whereas the video-averaging technique takes many sweeps to complete the average. Characteristics of the signal being measured, such as drift and duty cycle, determine which technique is appropriate.

Video averaging improves the display of low-level signals in wide bandwidths by averaging the signal and the noise. As the receiver takes sweeps, you can watch video averaging smooth the trace.

1. Set the receiver to a known state by pressing:

```
PRESET
BW
IF BW AUTO MAN ..... 30 kHz
```

2. Connect an antenna to Input 2 of the receiver and position a low-level signal on the screen.
3. Initiate the video averaging routine by pressing:

```
TRACE
More 1 of 3
VID AVG ON OFF ON
```

As the averaging routine smooths the trace, low-level signals become more visible. VID AVG 100 appears in the active function block.

The number represents the number of samples (or sweeps) taken to complete the averaging routine.

4. Set the number of samples by pressing:

```
VID AVG ON OFF ON ..... 25 (ENTER)
```

5. Turn video averaging off and on again by pressing:

```
VID AVG ON OFF OFF
VID AVG ON OFF ON
```

The number of samples equals the number of sweeps in the averaging routine.

During averaging, the current sample appears at the left side of the graticule. Changes in active functions settings, such as the center frequency or reference level, will restart the sampling. The sampling will also restart if video averaging is turned off and then on again.

Once the set number of sweeps has been completed, the receiver continues to provide a running average based on this set number.

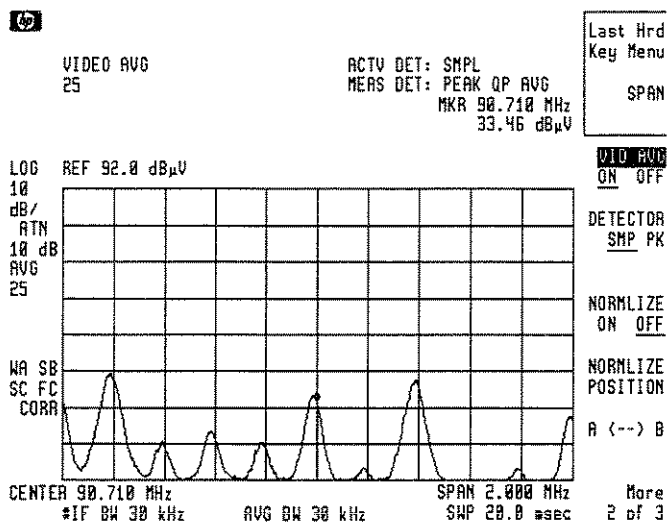

Figure 6-20. Using the Video Averaging Function

Testing for Distortion Using the Linearity Check

The linearity check function can be used to test for compression of low-level signals or for the presence of internally-generated distortion due to high-level input signals. This function simplifies the process of determining if the displayed signals are suitable for measurement. Additional input attenuation is switched in while you monitor the value of the marker located on the signal in question. This feature complements the RF overload function, which indicates when an overload *might* be present. It allows you to decide if the signal causing the overload is affecting the measurement of another signal.

Measuring Small Signals in the Presence of a Large Ambient Signal

Receiver overload due to large signals is one problem encountered when making measurements on an open site. When scanning over a frequency range which contains both a large ambient signal and a low-level DUT emission, the large signal may trigger the receiver overload indicator when the receiver sensitivity is set to view the small signal. While the receiver *is* in overload as it scans through the large signal, it may *not* be in overload as it scans through the small signal. The presence or absence of the overload depends on the frequency spacing between the two signals relative to the receiver input filter bandwidth. If the receiver is not in overload as it scans through the small signal, the measured value of that signal will be correct even though the receiver display indicates an overload has occurred. The Linearity Check function can be used to determine if the receiver is in overload under these conditions.

1. Connect two signal generators to the input of the receiver as shown in Figure 6-21. Set one signal to 300 Mhz, 92 dB μ V (-15 dBm) and the other to 305 MHz, 27 dB μ V (-80 dBm). Increase the amplitude of the 305 MHz signal if it is masked by the noise level of the 300 MHz source.

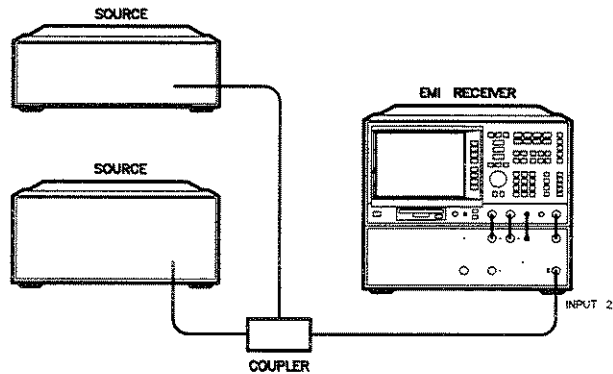

Figure 6-21. Set-Up for Obtaining Two Signals

2. Set the receiver to a known state by pressing:

..... 305
 20

 0

Note the IF OVERLOAD message on the display due to the 300 MHz signal.

3. To view and mark the 305 MHz signal, press:

..... 5

Note the fluctuations in the delta marker amplitude displayed in the active function area. When the signal is near the noise floor, the noise contributions will cause fluctuation in the marker value. This could be interpreted as overload induced error when is activated. To reduce the fluctuation, decrease the averaging bandwidth by pressing:

..... 1

Note the absolute level of the marker delta readout and the reduced range of the fluctuation.

4. Activate linearity check by pressing:

LINEARITY CHECK

If the delta marker amplitude and fluctuation changes by more than 1 dB, the receiver is in compression. In this example, the delta marker readings remain the same and a valid measurement can be made because the 305 MHz signal is not being affected by the 300 MHz signal.

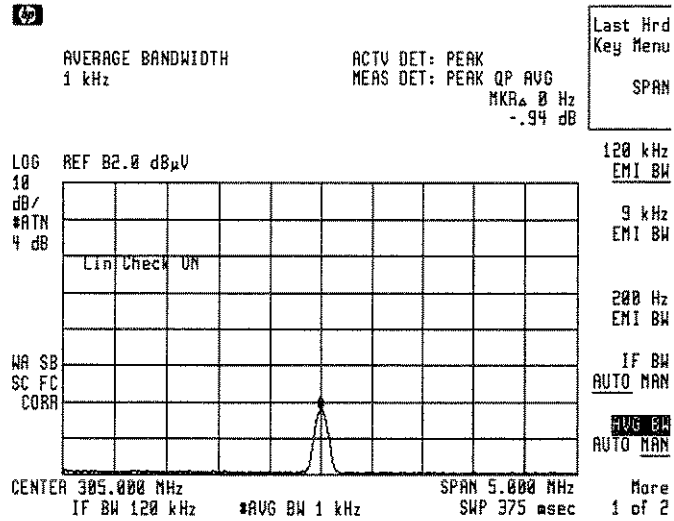

Figure 6-22. Using Linearity Check to Detect Compression

Using Linearity Check

The Linearity Check function can be used to determine if a signal displayed in the presence of a high level ambient is an actual emission or an internally generated distortion product. When the Linearity Check function is activated, the level of the distortion product will change but the level of an actual input signal will not.

1. Connect two signal generators to the input of the receiver as shown in Figure 6-23. Set one signal to 300 MHz, 92 dB μ V (-15 dBm) and the other to 305 MHz, 57 dB μ V (-50 dBm). Increase the amplitude of the 305 MHz signal if it is masked by the noise level of the 300 MHz source.

Note

These levels were intentionally chosen to overdrive the receiver and generate third order distortion products.

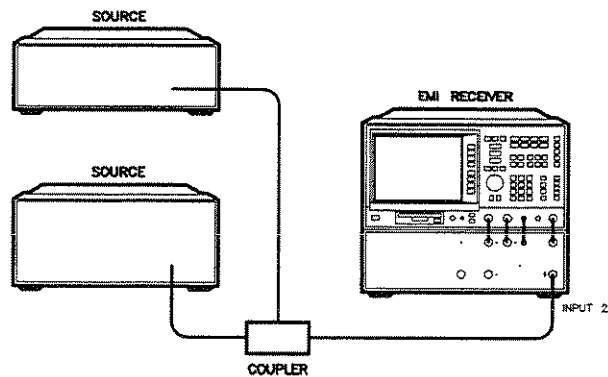

Figure 6-23. Set-Up for Obtaining Two Signals

2. Set the receiver to a known state by pressing:

CENTER FREQ 300
 20

 ATTEN AUTO MAN 0
 ON (Toggles on and off.)

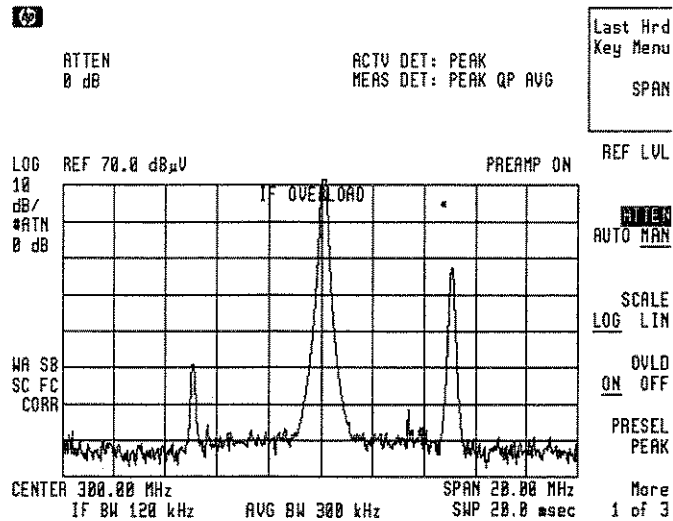

Figure 6-24. Generating Third Order Distortion Products

Note the IF OVERLOAD message.

3. Use the knob to place the marker on the 295 MHz signal. Center the signal on the display and decrease the span by pressing:

→
 MKR → CF
 5

4. Reduce the noise induced fluctuations by pressing:

AVG BW AUTO MAN 1

5. Observe the marker delta amplitude as you press:

Δ

6. Active the Linearity Check function by pressing:

Observe the drop in the measured signal.

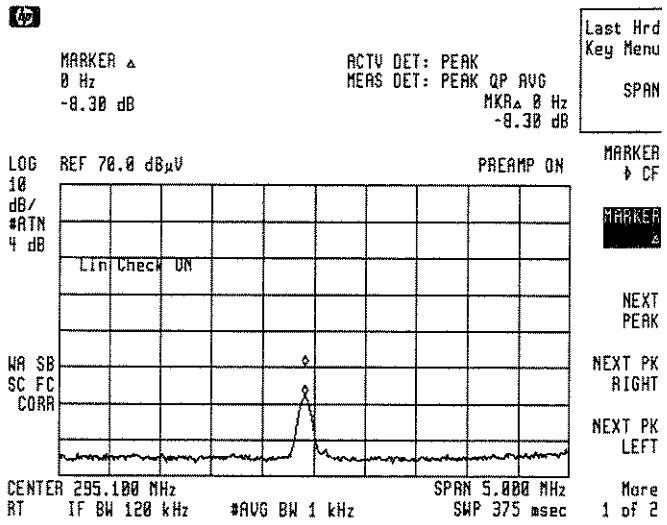

Figure 6-25.
Using Linearity Check to Identify Distortion Products

Demodulating and Listening to an AM or FM Signal

The functions available in the Demod section allow you to demodulate and hear signal information displayed on the spectrum analyzer. Simply place a marker on a signal of interest, activate AM or FM demodulation, and then listen.

1. Connect an antenna to Input 2 of the receiver.
2. Select a frequency range on the receiver, such as the range for FM radio broadcasts. For example, the frequency range for FM broadcasts in the United States is 88 MHz to 108 MHz. Press:

```
PRESET
FREQUENCY
START FREQ ..... 88 MHz
STOP FREQ ..... 108 MHz
```

3. Place a marker on the signal of interest by using **PEAK SEARCH** to place a marker on the highest-amplitude signal, or by pressing:

```
MKR
MARKER NORMAL
```

Use the step keys or knob to moving the marker to a signal of interest.

4. Turn demodulation on by pressing:

```
ON/OFF (Located in the DEMOD area of the front-panel.)
SELECT
DEMOD AM FM FM
```

Use the front-panel volume control to control the speaker's volume.

5. The signal at the marker is demodulated for the duration of the dwell time. Use the step keys, knob, or data keys to change the dwell time. To change the dwell time to two seconds, press:

```
SELECT
DWELL TIME, [↑], [↑]
```

6. The peak search functions can be used to move the marker to other signals of interest. Press **PEAK SEARCH** to access **NEXT PEAK**, **NEXT PK RIGHT**, or **NEXT PK LEFT**.

7. The signal at the marker can be continuously demodulated when the frequency scan is turned off by pressing:

```
TEST
FREQ SCAN ON OFF OFF
```

8. The FM sensitivity can be varied to better demodulate wideband or narrowband FM signals by adjusting the FM Gain located under **Select**. The default value is 100 kHz per volt.

Making Other Measurements

What You'll Learn in This Chapter

This chapter demonstrates receiver measurement techniques with examples of typical applications. Each application focuses on different features. The procedures covered in this chapter are listed below.

- Stimulus-response measurements
- Measuring amplitude modulation using FFT
- 3 dB and 6 dB bandwidth measurements
- 99% power bandwidth measurements
- Percent AM modulation measurements
- Amplitude and frequency difference measurements
- 3rd order measurements

Stimulus-Response Measurements

What Are Stimulus-Response Measurements?

Stimulus-response measurements require a source to stimulate a device under test (DUT), a receiver to analyze the frequency-response characteristics of the DUT, and, for return-loss measurements, a directional coupler. Characterization of a DUT can be made in terms of its transmission or reflection parameters. Examples of transmission measurements include flatness and insertion loss. An example of a reflection measurement is return loss.

A receiver combined with a tracking generator forms a stimulus-response measurement system. Using the tracking generator as the swept source operation is analogous to a single-channel scalar network analyzer. A narrow-band system has a wide dynamic measurement range, but the tracking generator's output frequency must be made to precisely track the receiver's input frequency. This wide dynamic range will be illustrated in the following example. Figure 7-1 shows the block diagram of a receiver and tracking generator system.

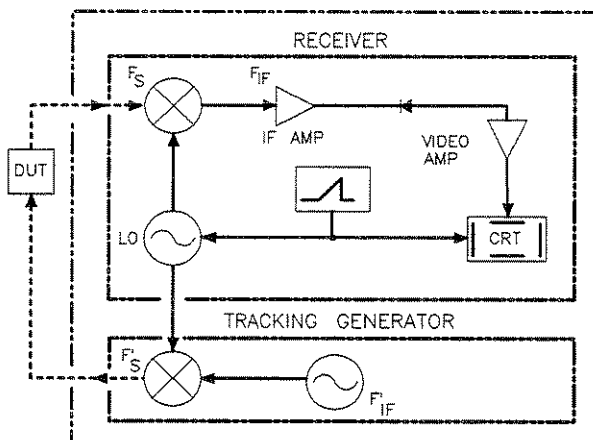

Figure 7-1. Receiver/Tracking Generator System Block Diagram

Using the Receiver With the Internal Tracking Generator

The procedure below describes how to use the built-in tracking generator system of the receiver to measure the rejection of a low-pass filter which is a type of transmission measurement. Illustrated in this example are the functions in the tracking-generator menu, such as adjusting the tracking-generator output power, source calibration, and normalization.

Stepping Through the Measurement

There are four basic steps in performing a stimulus-response measurement, whether it be a transmission or reflection measurement: set up the receiver settings, calibrate, normalize, and measure.

1. If necessary, perform the self-calibration routine for the tracking generator described in “Performing the Tracking Generator Self-Calibration Routine” in Chapter 2.
2. To measure the rejection of a bandpass filter, connect the equipment as shown in Figure 7-2. This example uses a bandpass filter with a center frequency of 321.4 MHz as the DUT.

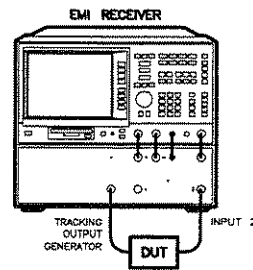

Figure 7-2. Transmission Measurement Test Setup

3. Set the receiver to a known state by pressing:

..... 321.4
 500
 102

4. Activate the tracking generator and turn the power on by pressing:

ON

CAUTION

Excessive signal input may damage the DUT. Do not exceed the maximum power that the device under test can tolerate.

Note

To reduce ripples caused by source return loss, use 10 dB or greater tracking generator output attenuation. Tracking generator output attenuation is normally a function of the source power selected. However, the output attenuation may be controlled by using .

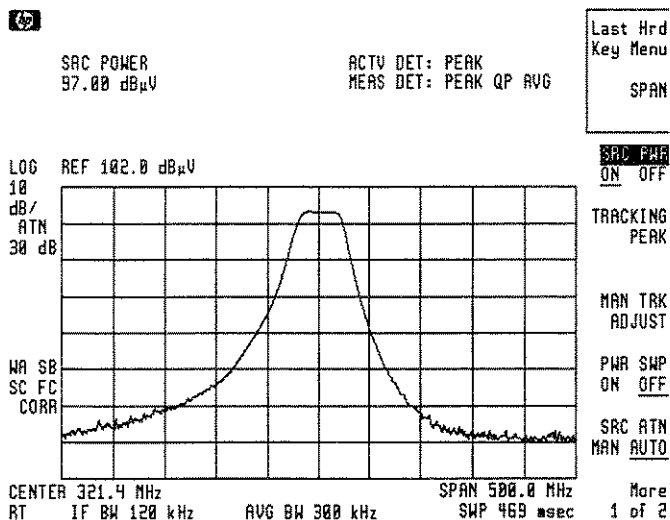

Figure 7-3. Tracking-Generator Output Power Activated

- Put the sweep time of the receiver into stimulus-response auto-coupled mode by pressing:

More 1 of 2
 SWP CPLG SR SA SR

Auto-coupled sweep times are usually much faster for swept-response measurements than for receiver measurements.

Note

In the stimulus-response mode, the Q (reactance versus resistance) of the DUT can determine the fastest rate at which the receiver can be swept. To determine whether the receiver is sweeping too fast, slow the sweep time and note whether there is a frequency or amplitude shift of the trace. Continue to slow the sweep time until there is no longer a frequency or amplitude shift.

- Decrease the resolution bandwidth to increase sensitivity, and narrow the averaging bandwidth to smooth the noise by pressing:

BW
 IF BW AUTO MAN 10 kHz
 AVG BW AUTO MAN 1 kHz

7. To make a transmission measurement accurately, the frequency response of the test system must be known. To measure the frequency response of the test system, connect the cable (but not the DUT) from the tracking generator output to the receiver input.

To store the frequency response of the test system in trace B, press:

TRACE
TRACE A B C B
CLEAR WRITE B
BLANK B

8. To normalize, reconnect the DUT to the receiver and press:

TRACE
More 1 of 3
NORMLIZE ON OFF ON

Activate the display line by pressing:

NORMLIZE POSITION

The display line marks the normalized reference position, or the position where 0 dB insertion loss (transmission measurements) or 0 dB return loss (reflection measurements) will normally reside. Using the knob results in a change in the position of the normalized trace, within the range of the graticule. Set the level so it is one graticule below the top of the display.

Normalization eliminates the frequency response error of the test system. When normalization is on, trace math is being performed on the active trace. The trace math performed is trace A minus trace B plus the display line, with the result placed into trace A. Remember that trace A contained the measurement trace, trace B contained the stored calibration trace, and DL (display line) represents the normalized reference position. Note that the units of the reference level, dB, reflect this relative measurement.

9. Measure the insertion loss of the filter at a given frequency (for example, 321.4 MHz) by pressing:

MKR 321.4 MHz

The marker readout displays the rejection of the filter at 321.4 MHz (refer to Figure 7-4).

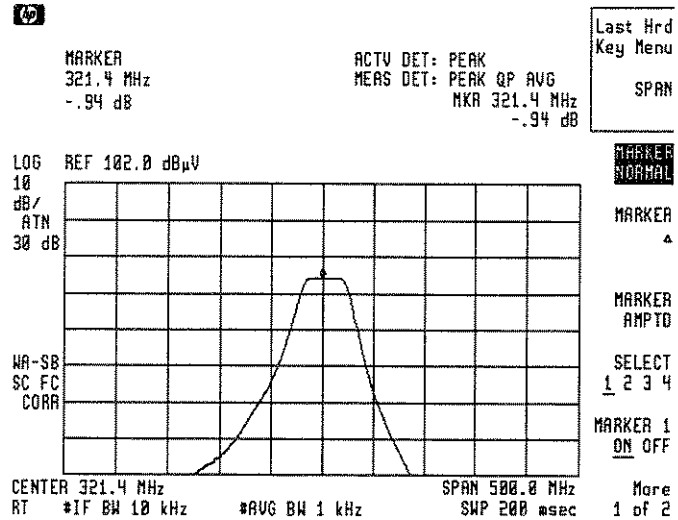

Figure 7-4. Normalized Trace

10. Measure the rejection of the filter relative to the passband by pressing:

MKR
MKR Δ 30 **MHz**

The Marker Δ amplitude readout displays the rejection at a 30 MHz frequency offset.

Tracking Generator Unleveled Condition

When using the tracking generator, the message TG UNLVL may appear. The TG UNLVL message indicates that the tracking generator source power (**SRC PWR ON OFF**) could not be maintained at the user-selected level during some portion of the sweep. If the unleveled condition exists at the beginning of the sweep, the message will be displayed immediately. If the unleveled condition occurs after the sweep begins, the message will be displayed after the sweep is completed. A momentary unleveled condition may not be detected when the sweep time is small. The message will be cleared after a sweep is completed with no unleveled conditions.

The unleveled condition may be caused by any of the following:

- Start frequency is too low or the stop frequency is too high. The unleveled condition is likely to occur if the true frequency range exceeds the tracking generator frequency specification (especially the low frequency specification). The true frequency range being swept may be significantly different than the start or stop frequency annotations indicate, depending on other receiver settings, especially the span (see Chapter 1 of the Reference Guide for your instrument). For better frequency accuracy, use a narrower span.
- Tracking peak may be required (use **TRACKING PEAK**).
- Source attenuation may be set incorrectly (select **SRC ATN MAN AUTO** (AUTO) for optimum setting).
- The source power may be set too high or too low, use **SRC PWR ON OFF** to reset it.
- The source power sweep may be set too high, resulting in an unleveled condition at the end of the sweep. Use **PWR SWP ON OFF** to decrease the amplitude.

Measuring Amplitude Modulation with the Fast Fourier Transform Function

The fast Fourier transform (FFT) function of the receiver allows measurements of amplitude modulation (AM). The FFT function transforms demodulated AM data from the time domain (zero span) to the frequency domain. The FFT function calculates the magnitude of each frequency block of time-domain samples of the input signal. It is commonly used to measure AM at rates that cannot be measured in the normal frequency domain. The FFT is a post-detection fast Fourier transform function and cannot be used to resolve continuous wave or carrier signals.

The FFT function requires a specific receiver configuration. An AM signal is demodulated in the time domain by widening the resolution bandwidth to include the signal sidebands within the passband of the receiver. Then the scan is turned off so the tuning is centered on the AM carrier.

When **MEAS/USER**, **FFT MEAS** is pressed, the function sets sample-detection mode and takes a sweep to obtain a sample of the input signal. Then the receiver executes a series of computations on the time data to produce the frequency-domain results.

Note

After the FFT function is used, the markers are still in FFT mode for use in evaluating data. Turn off the markers before attempting to use the markers in the normal fashion.

Measuring the Sidebands on a Signal

1. Connect a signal generator to the receiver input on the front panel. Adjust the signal generator to produce an AM signal at 300 MHz. (For example, set the modulation rate to 60 Hz with a 30% modulation level.)
2. Set the receiver to a known state by pressing:

PRESET
FREQUENCY
CENTER FREQ 300 **MHz**
SPAN 1 **MHz**

3. Set the IF bandwidth to 3 kHz by pressing:

BW
IF BW AUTO MAN 3 **kHz**

The IF bandwidth should be about 10 times greater than the highest modulation frequency of interest. (In this example, the fourth harmonic of 60 Hz is 240 Hz.)

4. Set the averaging bandwidth to 1 kHz by pressing:

AVG BW AUTO MAN 1 kHz

The averaging bandwidth should be about twice that of the highest modulation frequency of interest. If the averaging bandwidth is too large, "alias" signals may appear in the FFT when signals greater than the highest modulation frequency of interest are present.

5. Change the amplitude scale to linear by pressing:

AMPLITUDE
SCALE LOG LIN LIN

6. Change the reference level to place the signal peak within the top two divisions of the display by pressing:

REF LVL

Use the step keys or knob to adjust the signal. The signal must be below the reference level.

7. Turn frequency scan off by pressing:

TEST
FREQ SCAN ON OFF OFF

8. Refer to Figure 7-5, which shows maximum modulation frequency (f_m) in Hertz versus sweep time (T_s) in seconds. Set the sweep time less than $T_s(\text{man})$ for the maximum modulation frequency (f_m) including the harmonics of the signal. The upper curve relates the sweep time to the maximum modulation frequency that can be observed (that is, the modulation frequency represented by the right edge of the graticule). The lower curve represents the modulation frequency one division from the left side of the graticule.

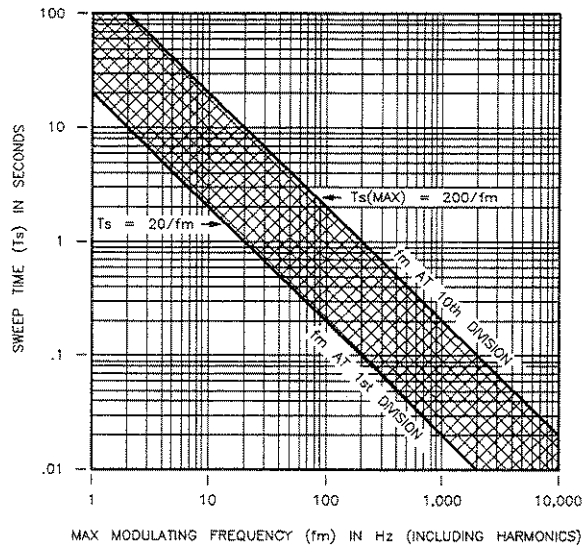

Figure 7-5.
Maximum Modulation Frequency versus Sweep Time

Set the sweep time so it falls in the shaded area between the two lines. Refer to Figure 7-5. Set it closer to the bottom line to avoid the effects of aliasing. Note the upper line (marked fm AT 10th DIVISION) represents sampling at exactly the Nyquist rate. Some aliasing may be seen when a value for sweep time is close to the upper line. (Frequencies greater than the maximum modulation frequency for a specific sweep time will not be displayed accurately.)

For example, set the sweep time according to the figure (for a right edge graticule limit of 250 Hz, select 800 ms) by pressing:

SWEEP 800 **ms**

9. To save the current receiver settings in instrument state 2, press:

SAVE
SAVE INTERNAL
STATE → INTRNL 2 **ENTER**

If you wish to repeat the measurement retrieve the receiver settings by pressing:

RECALL
INTRNL → STATE 2 **ENTER**

Note

If you want to prevent the receiver from taking a sweep before executing the FFT function, place trace A in the view mode.

10. To perform a fast Fourier transform, press:

MEAS/USER
FFT MEAS

When the transform is complete the frequency-domain data is displayed.

11. A marker is placed on the carrier at the 0 Hz reference (at the left edge of the display). To determine the frequency and amplitude difference from the carrier, press:

MKR
MARKER DELTA

Use the knob to move the marker to the modulation.

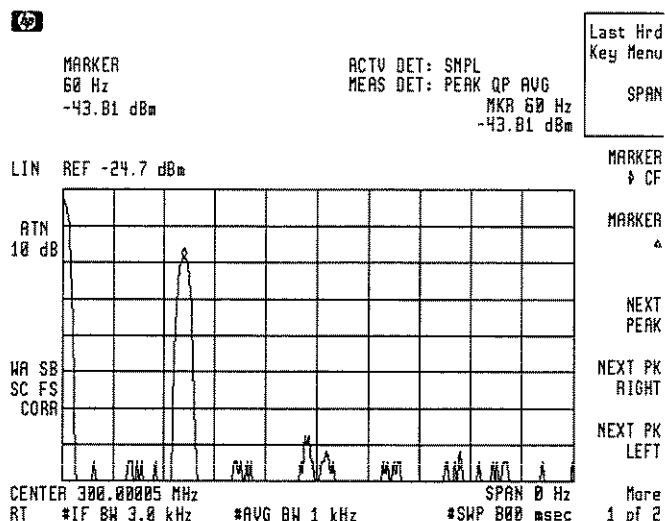

Figure 7-6. Using the FFT Function

The results of the FFT function are displayed on the receiver screen. The carrier is displayed at the left edge of the screen. The modulation sidebands and any distortion is displayed along the horizontal axis. The left edge of the graticule represents 0 Hz relative to the carrier. The right edge of the graticule represents the maximum FFT frequency calculated. In Figure 7-6 the maximum FFT frequency is 200 divided by the sweep time (250 Hz). The amplitude relationships between the carrier, sidebands, and distortion components are the same as they would be if displayed using swept-tuned operation in log mode at 10 dB per division.

Note

The annotation describes the settings before the FFT (linear mode, center frequency 300 MHz, span 0 Hz), and the marker annotation describes the settings after the FFT (log mode, signal at 60 Hz, maximum frequency is 250 Hz).

12. Turn off the markers by pressing:

MKR
MARKER 1 ON OFF OFF

Note

If the markers are not turned off after using the FFT function they will not work correctly when used with other settings.

Repeating the test

13. To repeat the test, clear the screen data by pressing:

TRACE
CLEAR WRITE A

14. Recall the instrument state by pressing:

RECALL
INTRNL → STATE2 **(ENTER)**

15. Continue the measurement from list item 10.

Measuring 3 dB and 6 dB Bandwidth

The EMI receiver allows you to measure the 3 dB or 6 dB bandwidth of a filter by pressing a single button. A delta marker measurement is performed on the largest on screen signal and the bandwidth is displayed in the active function area.

1. Set the receiver to a known state by pressing:

```

PRESET
INPUT
VIEW CAL ON OFF ON
FREQUENCY
CENTER FREQ ..... 300 MHz
SPAN ..... 2 MHz
    
```

2. Perform a 3 dB bandwidth measurement by pressing:

```

MEAS/USER
3 dB POINTS
    
```

3. Perform a 6 dB bandwidth measurement by pressing:

```

MEAS/USER
6 dB POINTS
    
```

The value is displayed in the active function block.

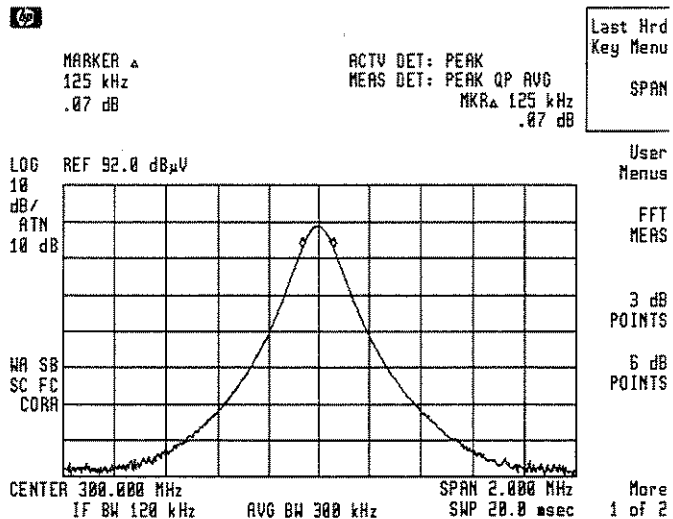

Figure 7-7. Using the 6 dB Points Function

Measuring 99% Power Bandwidth

The EMI receiver allows you to measure the power bandwidth of a signal by pressing a single button. The results is displayed in the active function area.

1. Tune the receiver so only the signal of interest is displayed.
2. Set the receiver to a known state by pressing:

```

PRESET
INPUT
VIEW CAL ON OFF ON
FREQUENCY
CENTER FREQ ..... 300 MHz
SPAN ..... 2 MHz
    
```

3. Measure the 99% power bandwidth by pressing:

```

MEAS/USER
More 1 of 2
99% PWR BW
    
```

The value is given in the active function block.

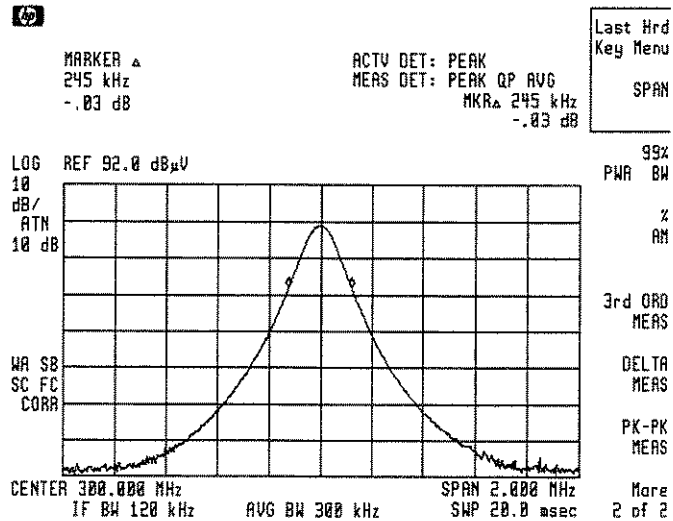

Figure 7-8. Using the 99% Pwr BW Function

Measuring Percent AM Modulation

Percent amplitude measurement can be measured quickly and easily by pressing a single key.

1. Connect a source capable of amplitude modulation to the receiver. Tune the source to 300 MHz and 80 dB μ V (-27 dBm). Set the modulation frequency to 10 kHz with a 30% modulation level.
2. Set the receiver to a known state by pressing:

```

PRESET
FREQUENCY
CENTER FREQ ..... 300 MHz
SPAN ..... 100 kHz
BW
IFBW AUTO MAN ..... 3 kHz
    
```

Note the corner signal and the sidebands.

3. Measure the percent amplitude modulation by pressing:

```

MEAS/USER
More 1 of 2
% AM
    
```

The percent of amplitude modulation is displayed in the active function block.

Note

The IF bandwidth must be set so the sidebands are displayed and the maximum amplitude excursion between displayed signals must be greater than the value set under Peak Excursion (default 6 dB). The sidebands are assumed to be entirely from amplitude modulation. At least one sideband must be displayed; if not, the measurement stops and 0% AM is displayed in the active area.

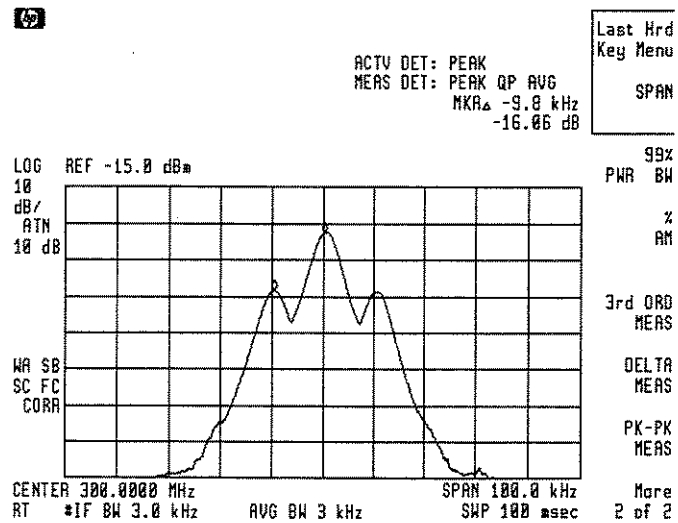

Figure 7-9. Using the % AM Function

Measuring Amplitude and Frequency Difference

Amplitude and frequency difference measurements between two signals can be made using the one-button Delta Meas and Pk-Pk functions. The Delta Meas function compares the two largest on screen signals and displays the difference in the active function area. The Pk-Pk function compares the largest and smallest on screen signal (or noise) and displays the difference in the active function area. A single measurement is made each time a button is pressed. The markers may be turned off after a measurement is made by pressing:

MKR
MARKER 1 ON OFF OFF

1. Set the receiver to a known state by pressing:

PRESET
INPUT
VIEW CAL ON OFF ON
FREQUENCY
STOP 700 **MHZ**

2. Measure the difference between the two highest peaks by pressing:

MEAS/USER
More 1 of 2
DELTA MEAS

The value is displayed in the active function block.

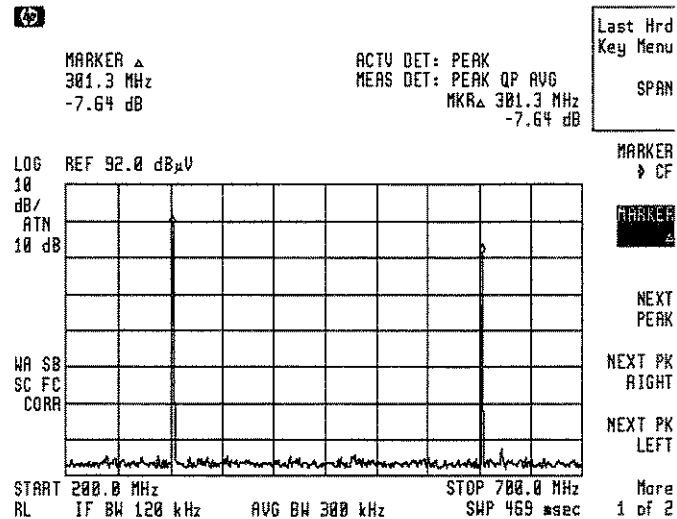

Figure 7-10. Using the Delta Meas Function

3. To measure the difference between the highest peak and the noise floor, press:

MEAS/USER

More 1 of 2

PK-PK MEAS

The value is displayed in the active function block.

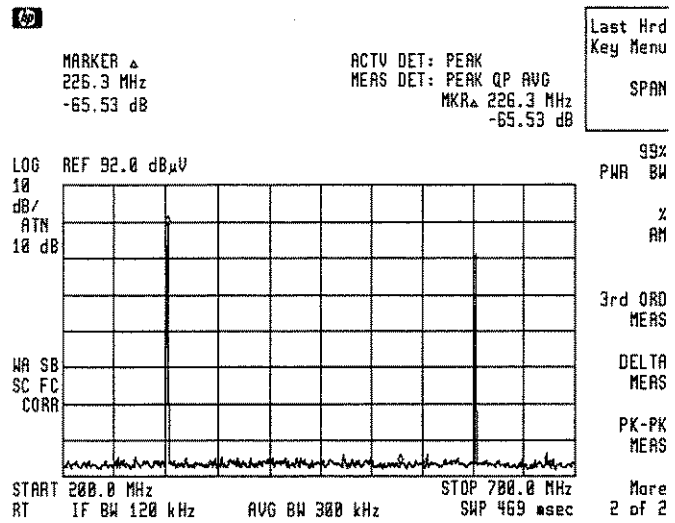

Figure 7-11. Using the Pk-Pk Function

Making 3rd Order Measurements

Two-tone, third order intermodulation distortion is a common problem in many electronic systems. When two signals are present in a system, they can mix with any generated second harmonics and create third order intermodulation distortion products. Third order product frequency and amplitude differences can be easily measured using the one-button 3rd Ord Meas function.

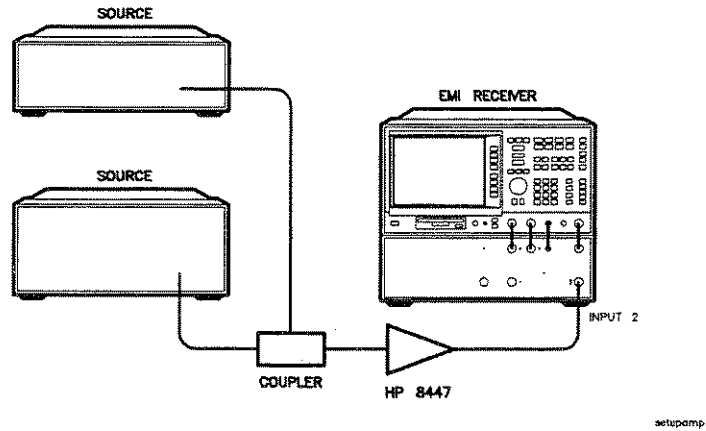

Figure 7-12. Setup for Making 3rd Order Measurements

1. Connect two sources to the receiver through an amplifier with the appropriate frequency range. Refer to Figure 7-12. Set one source to 300 MHz and 80 dB μ V (-27 dBm) and the other source to 301 MHz and 80 dB μ V (-27 dBm).

CAUTION

You may need to vary the source powers and/or frequencies, depending on the available test amplifier. Use sufficient input attenuation or sufficiently small signals to prevent damage to the input of the receiver.

2. Set the receiver to a known state by pressing:

..... 300
 5

3. Adjust the receiver so at least one of the fundamental signals and a third-order product is displayed.

4. Measure the amplitude and frequency differences by pressing:

MEAS/USER
More 1 of 2
3rd ORD MEAS

The value is displayed in the active function block.

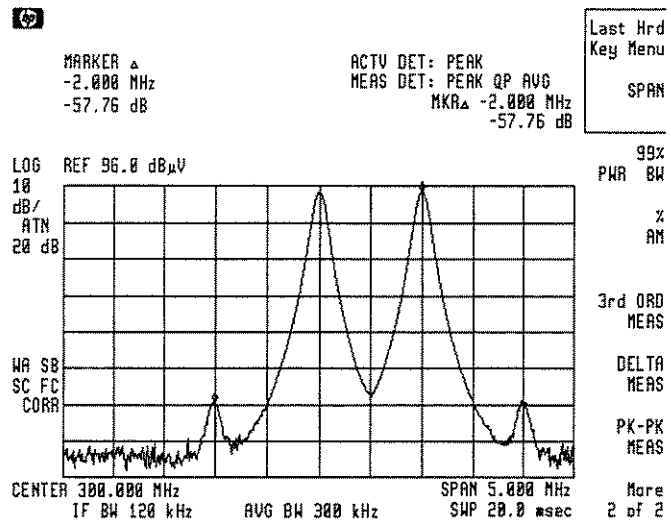

Figure 7-13. Using 3rd Ord Meas Function

Limit Lines

Limit lines provide an easy way to compare trace data to a set of amplitude and frequency parameters while the receiver is sweeping the measurement range.

Two limit lines with margins can be displayed on the EMI receiver. These limit lines can be used to visually determine whether displayed signals meet the appropriate limits. Margins are set relative to each of the limit lines, and are useful when taking into account any uncertainties that can exist in the entire measurement system.

If you wish to provide a margin of safety when testing to a limit, you may set a margin below the required limit. When the limit-test function is activated the EMI receiver automatically indicates onscreen whether or not a displayed signal passes or fails a displayed limit line or margin.

When limit testing is activated, the receiver automatically tests to either the limit-line or the margin, whichever is lowest. Failures are indicated both onscreen and over the HP-IB bus. When performing limit testing with two limit lines and their associated margins, the receiver automatically tests to the lowest of the four.

Limit lines are constructed from a table of frequency and amplitude coordinate pairs. Limit-line segments are created by connecting these points. Everything except the segment length is defined by the entry for its beginning point. There are several ways of entering the frequency/amplitude pairs. These are described in the following section.

Note

Limit lines can be created and edited from the front panel or remotely via HP-IB. Limit lines in a trace format can only be created using remote commands or a down-loadable program. Refer to the LIMHI and LIMILO commands in the *EMI Receiver Series Programmer's Guide* for more information.

This chapter contains procedures for creating, editing, viewing, saving, and recalling a limit line. Procedures are included for both receiver and signal analyzer modes.

Using Receiver Limit Lines

Creating, Editing, or Viewing a Limit Line

This example shows how to create and activate an upper limit line for the 300 MHz OUTPUT signal.

1. Set the instrument to a known state by pressing:

PRESET

2. Select EMI receiver mode by pressing:

MODE

EMI RECEIVER

3. Display the 300 MHz calibrator signal and its harmonics by pressing:

INPUT

VIEW CAL ON OFF ON

4. Set the center frequency and span by pressing:

FREQUENCY

CENTER FREQ 300 **MHz**

SPAN

500 **MHz**

(ENTER) (to disable the active function area)

5. To access the limit-line menus, press:

SETUP

More 1 of 3

Limit Lines

Note

Limit line structure in receiver mode is different than signal analysis mode and are not interchangeable. When an attempt is made to use a limit line that was created in signal-analysis mode, the message, SA Limits not allowed in RCVR mode. will be displayed.

6. To remove the limit lines, press:

```
Limit 1
DELETE LIMIT, DELETE LIMIT
Previous Menu
Limit 2
DELETE LIMIT, DELETE LIMIT
Previous Menu
```

After pressing DELETE LIMITS once, the message

“If you are sure, press key again to purge data”

will appear. Pressing DELETE LIMITS a second time purges the limit-line table. The **PRESET** key turns limit-line testing off (if it is on), but does not clear an existing limit-line table.

Note

You can create limit lines using either logarithmic or linear frequency and amplitude scales. The choice depends upon the limit line that you want to create.

7. To select the linear frequency and logarithmic amplitude scales, press:

```
Limit 1
EDIT LIMIT
Select Type
Select Axis
FREQ SCL LOG LIN LIN
AMPL SCL LOG LIN LOG
Previous Menu, Previous Menu
```

Note

When the frequency is entered, amplitude selection automatically becomes the active function. When the amplitude is entered, the type selection automatically becomes the active function. When the type is entered, frequency selection automatically becomes the active function. This speeds up data entry when you want to enter several coordinates.

8. To enter the first coordinate, press:

```
SELECT FREQ ..... 75 (MHz)
SELECT AMPLITUD ..... 47 (dBµV)
POINT
```

Note

- The segment type determines how the coordinate point of the current line segment is connected to the coordinate point of the next line segment. The segment type determines whether the line segment is horizontal, sloped, or a single point.

To specify the segment type, press:

```
EDIT LIMIT
Select Type
SLOPE, FLAT, or POINT
Previous Menu
```

- The coordinates for the second point must be entered before the first limit-line segment is displayed.

When entering coordinates, the frequency, amplitude and type fields will be listed with asterisks (***) until new values are entered. The new coordinate will be listed last until the frequency, amplitude, and type selections have been entered. Once a frequency, amplitude, and type selection have been entered, the coordinate will be sorted into the limit-line table according to its frequency.

9. To enter the second coordinate, press:

```
SELECT FREQ ..... 100 (MHz)
SELECT AMPLITUD ..... 47 (dBµV)
FLAT
```

10. Set remaining limit-line coordinates of 250 MHz with a slope of 47 dBµV/m, 400 MHz with a slope of 87 dBµV/m, and 500 MHz with a slope of 97 dBµV/m, by pressing:

```
SELECT FREQ ..... 250 (MHz)
SELECT AMPLITUD ..... 47 (dBµV)
SLOPE
SELECT FREQ ..... 400 MHz
SELECT AMPLITUD ..... 87 (dBµV)
SLOPE
SELECT FREQ ..... 500 MHz
SELECT AMPLITUD ..... 97 (dBµV)
SLOPE
```

Note

A total of thirty points can be specified for each limit line. The onscreen indicator displays the number of remaining memory locations.

11. When all coordinates are entered, press:

EDIT DONE

12. To turn limit testing on, press:

Limit 1 ON OFF ON

LMT TEST ON OFF ON

Note

When using the receiver RF section by itself, refer to "Receiver RF Section Annotation" in Chapter 1 of this manual.

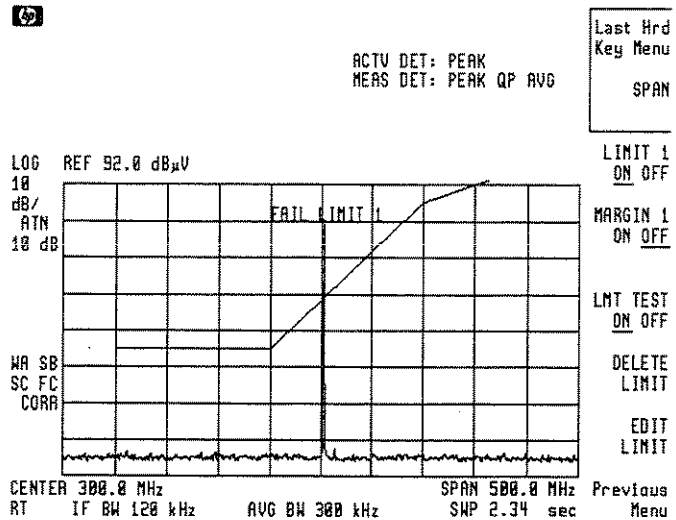

Completed Limit-Line

The message "FAIL LIMIT 1" is displayed because the calibration signal exceeds the limit line.

13. Turn the 300 MHz calibrator signal off by pressing:

INPUT

VIEW CAL ON OFF OFF

The message "PASS LIMIT" is displayed because no signal exceeds the limit line.

14. Turn the 300 MHz calibrator signal on by pressing:

VIEW CAL ON OFF ON

Editing an Existing Limit Line

- If you wish to add or modify segments in an existing table, press:

```

SETUP
More 1 of 3
Limit Lines
Limit 1
EDIT LIMIT
SELECT FREQ ..... 250 MHz
SELECT AMPLITUD ..... 57 dBμV
SLOPE
SELECT FREQ ..... 400 MHz
SELECT AMPLITUD ..... 57 dBμV
SLOPE
    
```

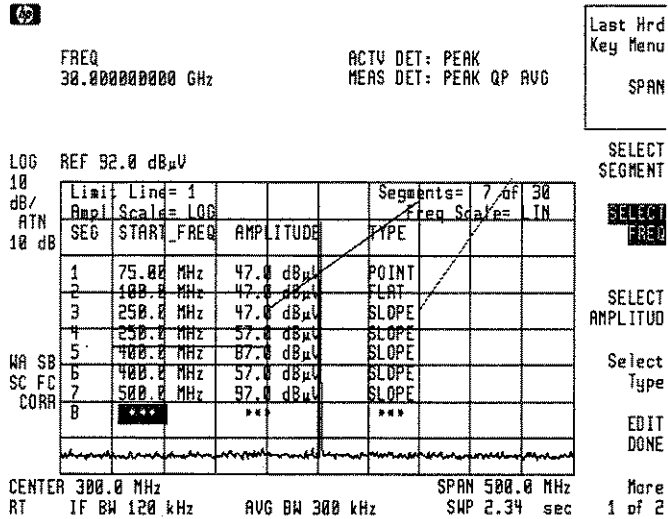

Editing an Existing Limit-Line Table

- To change the amplitude of segment number six from 57 dBμV/m to 102 dBμV/m, select the segment to be edited by pressing:

```
SELECT SEGMENT
```

- Use the step keys, number keys, or the knob to select row number six. Enter the new value by pressing:

```
SELECT AMPLITUD ..... 102 dBμV
```

- To delete segment number six, press:

```
Previous Menu
```

```
More 1 of 2
```

SELECT SEGMENT

5. Use the step keys, number keys, or the knob to select segment number six and then, press:

DELETE SEGMENT

6. When you finish editing the limit-line table, press:

More 2 of 2

EDIT DONE

Defining a Limit Margin

To set a -3 dB limit-line margin, press:

MARGIN 1 ON OFF ON 3 dB

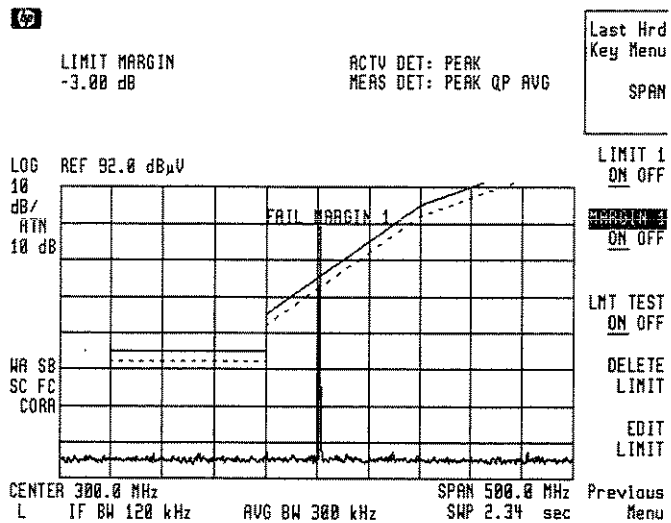

Signal Failing the Limit Line Margin

Note

- If the margin is displayed, limit-line testing is *applied to the margin* not the actual limit line. The limit and margin displays are independent. Limit-line testing must have either, or both, limit or margin displays ON.
- In linear amplitude displays, limit margins cannot be displayed for limit lines positioned more than 12 dB above the current reference level.

Activating Limit-Line Testing

When you are done editing, on off functions of the limit test become available.

To turn limit-line testing on, press:

```
LMT TEST ON OFF ON
```

The receiver can perform limit-line testing only if a limit is displayed. When limit-line testing is activated, the receiver automatically tests to either the limit-line or the margin, whichever is lowest. Failures are indicated both onscreen and over the HP-IB bus. When limit-line testing using two limit lines and their associated margins the receiver automatically tests to either the limit-lines or the margins, whichever of the four is lowest.

Saving or Recalling Limit-Line Tables

Saving a Limit-Line Table

1. Insert a formatted, blank disk in the floppy drive.
2. To save the current limit-line table, press:

```
SAVE
```

3. To enter a prefix, press:

```
Change Prefix
```

4. To clear an existing prefix, press:

```
YZ_# Spc Clear
```

```
Clear
```

5. Enter the prefix "DEMO" by pressing:

```
ABCDEF, D
```

```
ABCDEF, E
```

```
MNOPQR, M
```

```
MNOPQR, O
```

The message "PREFIX=DEMO" is displayed on the screen.

6. To save the current limit-line table to disk, press:

```
More 1 of 2
```

```
EDIT DONE
```

```
Save Disk
```

```
LIMITS → DISK
```

7. The register number is the active function. Enter register number one by pressing:

1 (ENTER)

The message "Saving to :DEM01.LIM" ("1DEM0_1" if using LIF format) is displayed. The limit-line data has now been saved to disk.

Note

The **SAVE LIMITS** function, located under the **SETUP** key, can also be used to save limit-line data. It is accessed by pressing:

SETUP

More 1 of 3

Limit Lines

SAVE LIMITS

The desired mass storage device and the prefix cannot be changed. They must be preset to the desired state before using this function. Only the register number can be entered.

Recalling a Limit-Line Table

1. To recall limit-line tables from the disk, press:

RECALL

Recall Disk

RECALL LIMITS

2. Use the step keys or knob to scroll through the displayed menu. When the desired file is highlighted, press:

LOAD FILE

Note

When a limit line is saved, the following information is stored:

- Limit 1 data, including the limit-line and margin information
- Limit 2 data, including the limit-line and margin information
- LIMIT 1 ON OFF status
- LIMIT 2 ON OFF status
- MARGIN 1 ON OFF status
- MARGIN 2 ON OFF status
- LIMIT TEST 1 ON OFF status
- LIMIT TEST 2 ON OFF status

Viewing the Disk Catalog

If you wish to see a list of the files on a disk you may use the catalog disk function.

1. Insert a disk into the floppy drive.
2. To view the catalog of limit-line files on the disk, press:

CATALOG DISK

Note the name of the desired file. (If using a DOS disk, the name will be "prefix register number.LIM". If using a LIF disk, the name will be "lprefix_register number".) The limit-line information you saved earlier will be displayed as, "DEMO1.LIM" (or "1DEMO_1" if using LIF format). Refer to Chapter 11 for more information on saving and recalling, and outputting data.

3. When you are finished viewing the catalog, press:

EXIT CATALOG

Using Signal Analyzer Limit Lines

Creating, Editing or Viewing a Limit Line

This example shows how to create an upper limit line for the 300 MHz OUTPUT signal and activate testing.

1. Set the instrument to a known state by pressing:

PRESET

2. Verify the mode selected is signal analysis by pressing:

MODE

SIGNAL ANALYSIS

3. Display the 300 MHz calibrator signal and its harmonics by pressing:

INPUT

VIEW CAL ON OFF ON

4. Set the center frequency and span by pressing:

FREQUENCY

CENTER FREQ 300 MHz

SPAN

..... 500 MHz

(ENTER) (to disable the active function area)

5. To access the limit-line menus, press:

SETUP

More 1 of 3

Limit Lines

Edit Limit

Selecting Limit-Line Parameters

1. The limits, frequency or time, function requires the limit-line parameters be entered as either frequency or time. Though coordinates of frequency and amplitude are used most often, limit-line data can also be entered in terms of time and amplitude. Frequency is the default selection. If TIME is selected START TIME will replace START FREQ in the edit limit menus.

Clear existing limits and select frequency by pressing:

LIMITS FRQ TIME, TIME (Clears existing limits.)

LIMITS FRQ TIME FRQ

2. To edit or create an upper limit line, press:

EDIT UPPER

Note

Limit line structure in signal analysis mode is different then receiver mode and are not interchangeable. When an attempt is made to use a limit line that was created in signal-analysis mode, the message, RCVR Limits not allowed in SA mode. will be displayed.

3. To remove this limit line, press:

More 1 of 2

PURGE LIMITS, PURGE LIMITS

EDIT UPPER

After pressing PURGE LIMITS once, the message

“If you are sure, press key again to purge data”

will appear. Pressing PURGE LIMITS a second time purges the limit-line table. (PRESET) turns limit-line testing off (if it is on), but does not clear an existing limit-line table.

4. To remove the error message, press:

(ENTER)

Note

The table defaults to fixed parameters. The middle of the table displayed onscreen should be labeled Limits=FIXED. If it is labeled Limits=RELATIVE, press:

More 1 of 2

LIMITS FIX REL FIX

The limits, fixed or relative, function determines whether or not the limit line is set relative to the receiver's center frequency and reference-level settings.

When time parameters are used, the relative format only affects the amplitude part of the coordinate pairs. The time parameters are always fixed, beginning at the left edge of the graticule.

Selecting the Amplitude Scale

To select the amplitude scale, press:

More 1 of 2
More 2 of 2
Select Type
Select Axis
FREQ SCL LOG LIN LIN
AMPL SCL LOG LIN LOG
Previous Menu, Previous Menu

Note

When entering coordinates frequency, amplitude, and type fields will be listed with asterisks (***) until new values are entered. The new coordinate will be listed last until the frequency, amplitude, and type selections have been entered. Once a frequency, amplitude, and type selection have been entered, the coordinate will be sorted into the limit-line table according to its frequency.

Set the beginning or the first limit-line segment to 50 MHz, with an amplitude of 47 dB μ V/m by pressing:

SELECT FREQ 50 MHz
SELECT AMPLITUD 47 dB μ V
FLAT

Note

The coordinates for the second point must be entered before the first limit-line segment will be displayed.

Set the beginning of the second limit-line segment to 250 MHz with a slope of 47 dB μ V/m by pressing:

SELECT FREQ 250 MHz
SELECT AMPLITUD 47 dB μ V
SLOPE

Note

Table entries can be edited if you make a mistake. To edit an existing segment, select the segment. Select the frequency, or amplitude of the column to be edited.

Set the third limit-line segment to 400 MHz with an amplitude of 92 dB μ V/m by pressing:

SELECT FREQ 400 MHz
SELECT AMPLITUD 92 dB μ V
SLOPE

Set the fourth limit-line segment to 600 MHz with an amplitude of 92 dB μ V/m by pressing:

SELECT FREQ 600 MHz
SELECT AMPLITUD 92 **dB μ V**
SLOPE

Note Segments can be defined even if they are out of the display range.

After all the segments have been entered, press:

More 1 of 2
EDIT DONE

To turn limit testing on, press:

LMT TEST ON OFF ON

The message "FAIL UPPER" is displayed because the calibration signal exceeds the limit line.

Note When on, the limit-test function tests to the defined limits, even if they are not displayed.

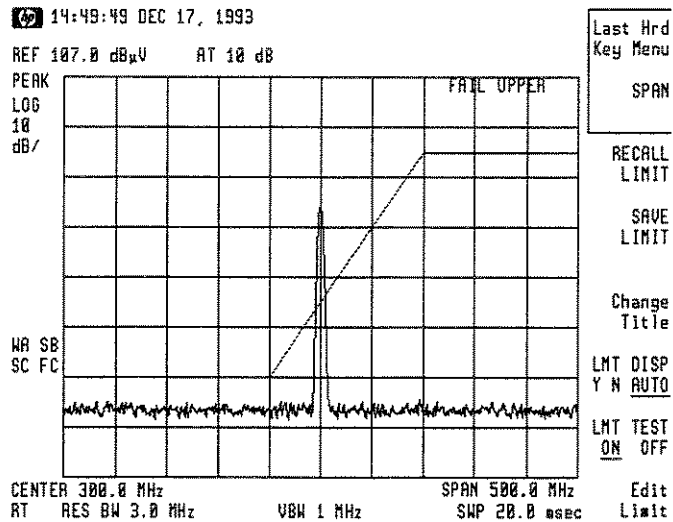

Signal Exceeding the Limit Line

Turn off the 300 MHz calibrator signal by pressing:

INPUT
VIEW CAL ON OFF OFF

The message "PASS LIMIT" is displayed because no signal exceeds the limit line.

Selecting the Limit-Line Table Format

You can use any of the following keys to create or edit a limit-line table:

Edit Upper

Edit Lower

Edit Up/Low

Edit Mid/Delt

Each of the edit softkeys represents a different kind of limit-line table format. The choice depends on whether you want only an upper limit line, only a lower limit line, or both an upper and a lower limit line. If both an upper and a lower limit line are desired, the characteristics of the desired limit lines will determine whether you select the **Edit Up/Low** or **Edit Mid/Delt** function.

The four limit-line table formats are described below:

Edit Upper

Accesses the upper limit-line table format. One amplitude component (representing an upper limit-line segment) is specified for each frequency (or time) component.

Edit Lower

Accesses the lower limit-line table. One amplitude component (representing a lower limit-line segment) is specified for each frequency (or time) component.

Edit Up/Low

Accesses the upper/lower limit-line table format. Two amplitude components (one each for the upper and lower limit-line segments) can be specified for each frequency or time component.

Edit Mid/Delt

Accesses the mid/delta limit-line table format. Two amplitude components (one representing a mid-amplitude value, one representing a deviation or delta (positive and negative values) from either side of this value) is specified for frequency component. If no deviation is entered, the deviation defaults to zero.

Note

- When editing a limit line table you may use a format different than the one used when creating it.
- Frequency or amplitude values that are not within the receiver's maximum range will be modified.

Activating Limit-Line Testing

When **EDIT DONE** is pressed the **LMT TEST ON OFF** and **LMT DISP Y N AUTO** functions become available.

To turn limit-line testing on, press:

LMT TEST ON OFF ON

Note

If **LMT DISP Y N AUTO N**, the limit line is not displayed. If **LMT DISP Y N AUTO Y**, the limit line is displayed.

Pressing **LMT DISP Y N AUTO AUTO** sets the limit line display to match the limit-line test function. When **AUTO** is selected, the limit lines are only displayed when **LMT TEST ON OFF ON** is selected.

For information on selecting segment types and saving or recalling limit-line tables, refer to the appropriate sections earlier in this chapter.

Amplitude Correction Functions

The EMI receiver allows three types of amplitude-correction factors to be applied to the input signals.

- Antenna Factors Conversion factors relating field strength to measured voltage.
- Cable Factors Conversion factors to correct for cable insertion loss.
- Other Factors Correction factors to account for the effects of any other two-port device placed between the antenna and the receiver.

Creating, Editing, or Viewing the Amplitude-Correction Tables

In this example, an antenna amplitude-correction factor will be created.

1. Preset the receiver to a known state by pressing:

```

PRESET
SETUP
200 MHz-1 GHz
FREQUENCY
START FREQ ..... 300 MHz
STOP FREQ ..... 1 GHz
    
```

Note

The EMI receiver must be calibrated in order to use amplitude correction. If "CORR" is not displayed on the screen, you should perform a calibration. Refer to "Calibrating the EMI Receiver" in Chapter 2 for more information.

2. To create, edit, or view the amplitude-correction factors for antennas, press:

```

SETUP
More 1 of 3
Correctn Factors
Antenna Factors
    
```

Note

Creating, editing, and viewing the antenna, cable and other amplitude-correction tables follow identical procedures. If you wish to create a cable or other amplitude-correction table, select Cable Factors or Other Factors instead of Antenna Factors.

To delete any existing antenna amplitude-correction factors, press:

EDIT ANTENNA

More 1 of 2

DELETE FACTORS, **DELETE FACTORS**

(Press only once if the table is empty.)

More 2 of 2

Note

- After pressing the **DELETE FACTORS** softkey once, the message “If you are sure, press key again to delete factors” will appear. Pressing the **DELETE FACTORS** softkey a second time deletes the antenna amplitude-correction factors.
- When the frequency is entered, amplitude selection automatically becomes the active function. When the amplitude is entered, the correction point is incremented, and the frequency selection automatically becomes the active function. This speeds up data entry when you want to enter several coordinates.

3. To select an antenna amplitude-correction factor of 0 dB at 300 MHz, press:

SELECT FREQ 300 **MHz**

SELECT AMPLITUD 0 **dB**

4. Continue to add correction factors of 20 dB at 400 MHz and 0 dB at 5 GHz by using the following key sequence:

SELECT FREQ 400 **MHz**

SELECT AMPLITUD 20 **dB**

SELECT FREQ 5 **GHz**

SELECT AMPLITUD 0 **dB**

Note

A total of 80 correction points can be specified for each data set. They can be distributed among the three categories in any combination, however, the data sets can contain no more than a total of 80 unique frequency values.

When antenna, cable, and other points are specified at the same frequency, the data is stored as one point. For example, if you specify:

- an antenna point at 300 MHz, 19 dB
- a cable point at 300 MHz, -3 dB
- an other point at 300 MHz, -10 dB

then:

$$19 \text{ dB} + (-3 \text{ dB}) + (-10 \text{ dB}) = 6 \text{ dB}$$

and the final correction factor of 6 dB is stored in a single memory location. In this case, it would be possible for the total number of actual points to exceed eighty. The onscreen indicator displays the number of remaining memory locations.

The amplitude-correction factor applied to the lowest selected frequency is also applied to all frequencies *below* the lowest selected frequency. The amplitude-correction factor applied to the highest selected frequency is also applied to all frequencies *above* the highest selected frequency.

5. To convert the amplitude values to antenna field-strength units, press:

More 1 of 2

Antenna Units

$\mu\text{V}/\text{m}$

The receiver will now display amplitude units as $\mu\text{V}/\text{m}$ antenna field-strength units.

6. To select a correction based on a logarithmic frequency scale, press:

```

Previous Menu
FREQ SCL LOG LIN LOG
More 2 of 2
EDIT DONE

```

Note

When using the HP 85422E/HP 85462A receiver RF section by itself, refer to "Receiver RF Section Annotation" in Chapter 1 of this manual.

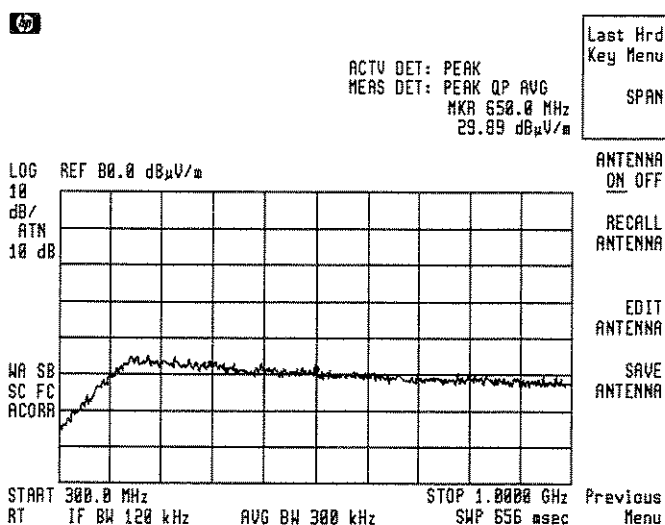

Conversion Factors Defined with a Log Frequency Scale

Note

Logarithmic frequency scale corrections are linearly interpolated between correction points with respect to the logarithm of the frequency. These correction points become straight lines on a log-frequency scale. The interpolation is computed as:

$$y(f) = \frac{y_{i+1} - y_i}{f_{i+1} - f_i} \log(f - f_i) + y_i$$

Linear frequency scale corrections are interpolated along straight lines, connecting adjacent points on a linear-frequency scale. The interpolation is computed as:

$$y(f) = \frac{y_{i+1} - y_i}{f_{i+1} - f_i} (f - f_i) + y_i$$

7. To select a correction based on a linear frequency scale, press:

```

EDIT ANTENNA
More 1 of 2
FREQ SCL LOG LIN LIN
More 2 of 2
EDIT DONE
  
```

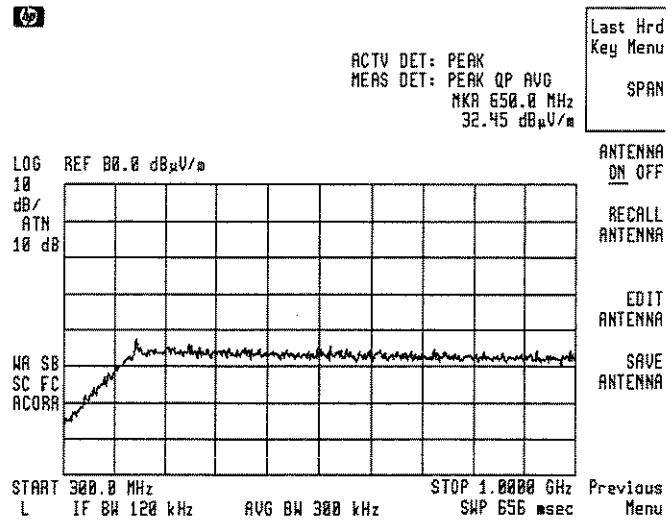

Conversion Factors Defined with a Linear Frequency Scale

8. To add an additional frequency coordinate at 500 MHz and 0 dB, press:

```

EDIT ANTENNA
SELECT FREQ ..... 500 (MHz)
SELECT AMPLITUD ..... 0 (dB)
  
```

Note

When entering coordinates, the frequency and amplitude fields will be listed with asterisks (***) until new values are entered. The new coordinate will be listed last until both the frequency and amplitude values have been entered. Once a frequency and an amplitude value have been entered, the coordinate will be sorted into the amplitude-correction table according to its frequency.

9. To edit the third row of antenna amplitude-correction factors, press:

SELECT POINT

Use the arrow keys or the knob to select point three.

10. To change the amplitude coordinate to -18 dB, press:

SELECT AMPLITUD 18 **-dBμV**

EDIT DONE

11. To prevent the amplitude-correction information from being lost when the receiver is turned off, press:

SAVE ANTENNA 2 **(ENTER)**

The message "Saving to CURRENT PREFIX2.ANT" ("nCURREN PREFIX_2" if using LIF format) is displayed. When the message disappears, the antenna amplitude-correction data has been saved on disk.

Activating Amplitude Correction

To turn amplitude corrections on, press:

SETUP

More 1 of 3

Correctn Factors

CORRECTN ON OFF ON

Note

When amplitude correction is turned off, all of the three possible correction factors (antenna, cable and other) are disabled. When amplitude-correction factors are turned on, only the correction factors you turned on will be enabled. For example, if you have selected:

ANTENNA ON OFF ON

CABLE ON OFF ON

OTHER ON OFF OFF

then all amplitude-correction factors will be disabled when the amplitude correction is turned off. When amplitude correction is turned on, only the antenna and cable amplitude-correction factors will be enabled.

Saving or Recalling

1. To save or recall the amplitude-correction factors, press:

SETUP

More 1 of 3

Correctn Factors

Antenna Factors, Cable Factors, or Other Factors

SAVE ANTENNA or RECALL ANTENNA

or

SAVE CABLE or RECALL CABLE

or

SAVE OTHER or RECALL OTHER

Note

The SAVE softkeys save the current amplitude-correction factors to a disk. The amplitude-correction factors can only be saved to a disk.

2. To save the correction factors, press:

SAVE ANTENNA, SAVE CABLE, or SAVE OTHER

3. To save the information, press:

A register number **(ENTER)**

The message "Saving to DEMOx.ANT" ("nDEMO_x" if using LIF format) is displayed. When the message disappears, the data has been saved to a disk.

4. To recall amplitude-correction factors from the disk, press:

RECALL ANTENNA, RECALL CABLE, or RECALL OTHER

5. Use the step keys to highlight the desired file, and then press:

LOAD FILE

Windows

Learn About the Windows Display

Windows display mode splits the instrument display into two frequency or time displays.

When windows is first turned on, the top (overview) window contains an inactive copy of the normal display. The lower (applications) window is active and displays a subset of the frequency span of the overview window. The span of the applications window is indicated on the overview window by a pair of vertical lines called zone markers. The zone markers indicate the portion of the overview window that is displayed in the applications window. To look at different portions of the overview window move the zone markers using the zone center and zone span softkeys.

The instrument state of the active window can be changed without affecting the state of the inactive window. The state of the active window will be used as the state of the instrument for sweeping and updating trace data.

For the purpose of this example, use the windows display mode to view the 300 MHz calibrator signal.

1. Preset the instrument to a known state by pressing:

PRESET

2. Activate the 300 MHz calibrator signal and its harmonics by pressing:

INPUT

VIEW CAL ON OFF ON

- To view additional harmonic signals set the receiver stop frequency to 2.9 GHz by pressing:

FREQUENCY

Stop Freq 2.9 **GHz**

Note

When using the receiver RF section by itself, refer to "Receiver RF Section Annotation" in Chapter 1 of this manual.

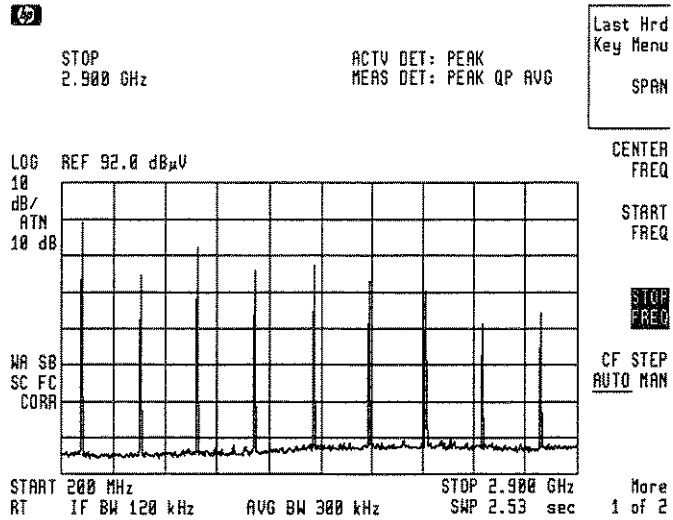

300 MHz Calibrator Signal with Harmonics

- Activate the windows function by pressing:

CTRL

The active window is outlined with a bold line.

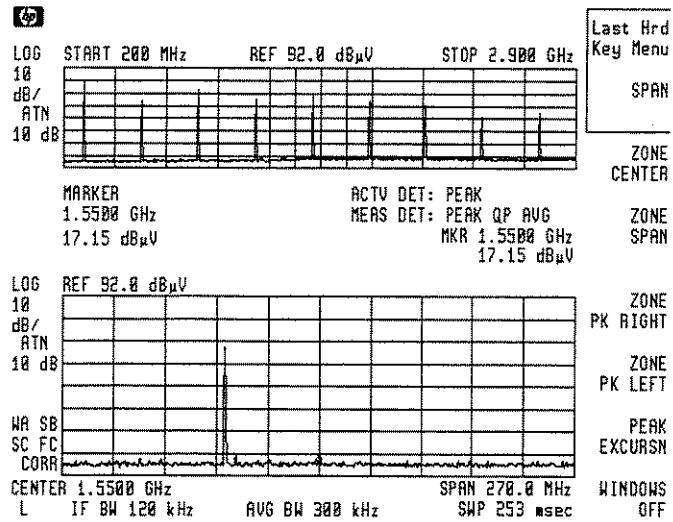

Windows Display Mode On

5. Move the zone markers to the first signal to the right of the current zone by pressing:

ZONE PK RIGHT

The zone is centered around the new signal.

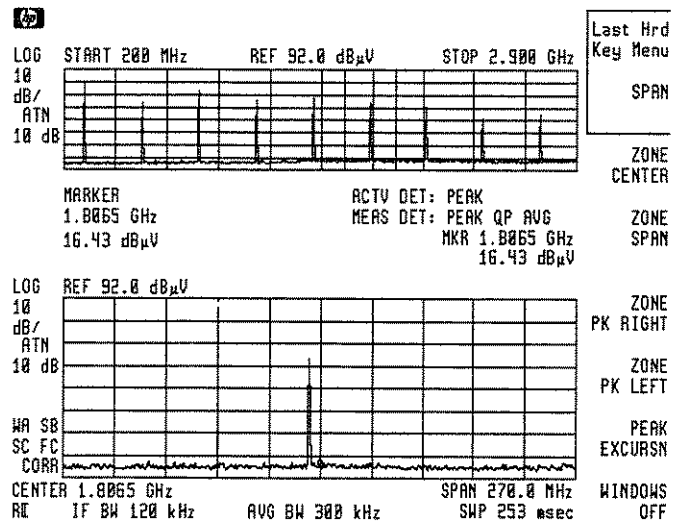

Zone Markers Moved to the Right of the Current Span

6. Move the zone markers to the first signal to the left of the zone by pressing:

ZONE PK LEFT

The zone is centered around the new signal.

7. Increase the zone span to include three signals by pressing:

ZONE SPAN

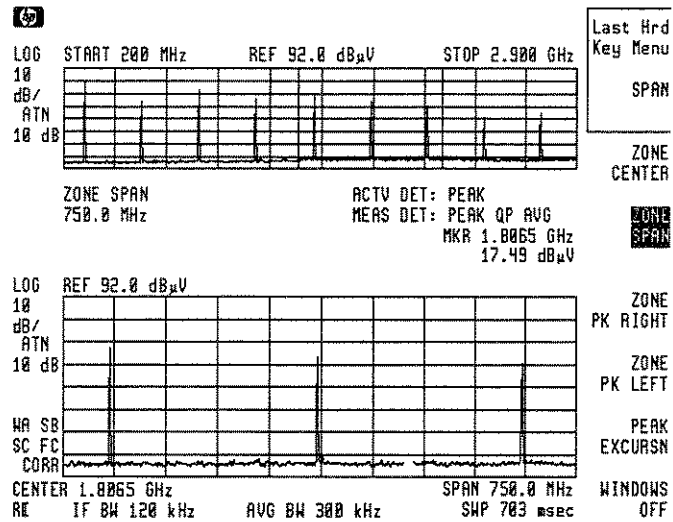

Zone Span Increased to Include Three Signals

8. View a full-sized display of the applications window by pressing:

ZOOM



ZONE SPAN
750.0 MHz

ACTV DET: PEAK
MERS DET: PEAK QP AVG
MKR 1.8065 GHz
17.66 dB μ V

Last Hrd
Key Menu

SPAN

LOG REF 92.0 dB μ V

10
dB/
ATN
10 dB

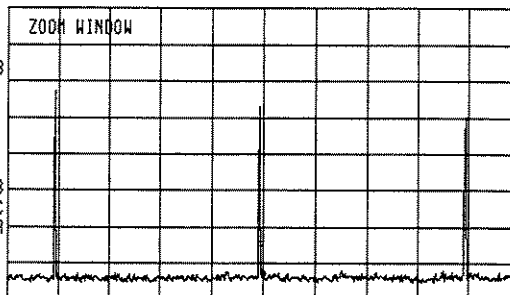

ZONE
CENTER

ZONE
SPAN

ZONE
PK RIGHT

ZONE
PK LEFT

PEAK
EXCURSN

CENTER 1.8065 GHz

RT IF BW 120 kHz

AVG BW 300 kHz

SPAN 750.0 MHz

SWP 703 msec

WINDOWS
OFF

Full-Sized Display of the Applications Window

9. View and activate a full-sized display of the overview window by pressing:

NEXT

The applications window is now active.



STOP
2.900 GHz

ACTV DET: PEAK
MERS DET: PEAK QP AVG

Last Hrd
Key Menu

SPAN

LOG REF 92.0 dB μ V

10
dB/
ATN
10 dB

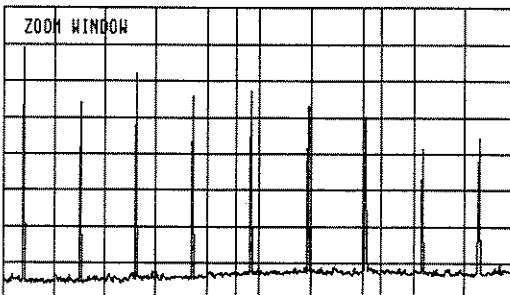

ZONE
CENTER

ZONE
SPAN

ZONE
PK RIGHT

ZONE
PK LEFT

PEAK
EXCURSN

START 200 MHz

RL IF BW 120 kHz

AVG BW 300 kHz

STOP 2.900 GHz

SWP 2.53 sec

WINDOWS
OFF

Full-Sized Display of the Overview Window

10. Return to the windows display mode by pressing:

ZOOM

11. Return to normal display mode of operation by pressing:

WINDOWS OFF

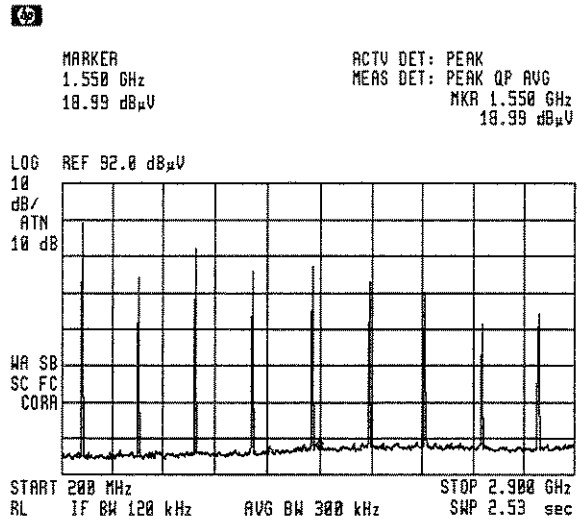

Windows Display Mode Off

12. To turn on the windows format again with the current display as the new overview window, press:

CTRL

A new applications window will be generated based on the zone in the overview window.

Note

Markers can be used in both windows, but they must be turned on in each window. The current limit lines are common to both windows.

Contents Guide

Limit Line and Antenna Factors Library Disk



HP Part No. 85462-90003
Printed in USA January 1994

Notice.

The information contained in this document is subject to change without notice.

Hewlett-Packard makes no warranty of any kind with regard to this material, including but not limited to, the implied warranties of merchantability and fitness for a particular purpose. Hewlett-Packard shall not be liable for errors contained herein or for incidental or consequential damages in connection with the furnishing, performance, or use of this material.

© Copyright Hewlett-Packard Company 1994
All Rights Reserved. Reproduction, adaptation, or translation without prior written permission is prohibited, except as allowed under the copyright laws.
1400 Fountaingrove Parkway, Santa Rosa CA, 95403-1799, USA

General Information

This document provides a directory description for the Limit Line and Antenna Factors Library Disk included with this kit. The disk is formatted for DOS and can be cataloged on any IBM-compatible computer. This disk contains: conducted limit lines, radiated limit lines, and antenna factors. Refer to the tables below for detailed descriptions for each file.

Conducted Limit Lines

Filename	Description
en022_ac.lim	EN55022 Class A Conducted Limits*
en022_bc.lim	EN55022 Class B Conducted Limits*
fcc15_ac.lim	FCC Part 15, Class A Conducted Limits
fcc15_bc.lim	FCC Part 15, Class B Conducted Limits
vcci_1c.lim	VCCI, Class 1 Conducted Limits*
vcci_2c.lim	VCCI, Class 2 Conducted Limits*
en011_a1.lim	EN55011 Class A, Group 1 Conducted Limits*
en011_a2.lim	EN55011 Class A, Group 2 Conducted Limits*
en011_bc.lim	EN55011 Class B, Groups 1 and 2 Conducted Limits*
en014_hl.lim	EN55014 Interference Limits household (150 kHz to 30 MHz)
en014_p1.lim	EN55014 Interference Portable tools 700 W (150 kHz to 30 MHz)
en014_p2.lim	EN55014 Interference Portable tools 700 to 1000 W (150 kHz to 30 MHz)
en014_p3.lim	EN55014 Interference Portable tools 1000 to 2000 W (150 kHz to 30 MHz)
en014_hh.lim	EN55014 Interference Limits household (30 MHz to 300 MHz)
en014_p4.lim	EN55014 Interference Portable tools 700 W (30 MHz to 300 MHz)
en014_p5.lim	EN55014 Interference Portable tools 700 to 1000 W (30 MHz to 300 MHz)
en014_p6.lim	EN55014 Interference Portable tools 1000 to 2000 W (30 MHz to 300 MHz)
vfg43_cp.lim	VFG 243/1991 (conducted: power lines)*
vfg43_cs.lim	VFG 2443/1991 (conducted: signal and control lines)*

* Limit-line 1 contains the Quasi-Peak limit value; Limit-line 2 contains the Average limit value.

Radiated Limit Lines

Filename	Description
en022a10.lim	EN55022 Class A Radiated, 10 m limit
en022a30.lim	EN55022 Class A Radiated, 30 m limit
en022b10.lim	EN55022 Class B Radiated, 10 m limit
fcc15a10.lim	FCC Part 15, Class A Radiated, 10 m limit
fcc15b3m.lim	FCC Part 15, Class B Radiated, 3 m limit
vcci1_3m.lim	VCCI, Class 1 Radiated, 3 m limit
vcci1_10.lim	VCCI, Class 1 Radiated, 10 m limit
vcci2_3m.lim	VCCI, Class 2 Radiated, 3 m limit
vcci2_10.lim	VCCI, Class 2 Radiated, 10 m limit
vde71_1a.lim	VDE 0871 Part 11; Group 1, Class A Radiated 30 m limit
vde71_2a.lim	VDE 0871 Part 11; Group 2, Class A Radiated 30 m limit
vde71_1b.lim	VDE 0871 Part 11; Group 1, Class B Radiated 10 m limit
vde71_2b.lim	VDE 0871 Part 11; Group 2, Class B Radiated 10 m limit
vfg43_10.lim	VFG 243/1991 (electric field, 10 m)
vfg43_3m.lim	VFG 243/1991 (magnetic field, 3m)
en011a1r.lim	EN55011 Test Site Radiated, 30 m distance, Class A
en011b1r.lim	EN55011 Test Site Radiated, 10 m distance, Class B, Group 1
en011a2r.lim	EN55011 Test Site Radiated, 30 m distance, Class A, Group 2
en011b2r.lim	EN55011 Test Site Radiated, 10 m distance, Class B, Group 2

Antenna Factors

Filename	Description
lism.ant	Transducer Factors for HP 11967C Line Impedance Stabilization Network (10 kHz to 105 MHz)
biconic1.ant	Antenna Factors for HP 11966C Biconical Antenna (30 MHz to 300 MHz) at 3 m spacing
log_perd.ant	Antenna Factors for HP 11966D Periodic Antenna (200 MHz to 1 GHz) at 3 m spacing
hf_log.ant	Antenna Factors for HP 11966N HF Log Periodic Antenna (200 MHz to 5 GHz) at 3 m spacing
horn.ant	Antenna Factors for HP 11966E Double-Ridged Waveguide Horn Antenna (1 GHz to 18 GHz) at 3 m spacing
hp11940a.ant	Typical Antenna Factors for HP 11940A Probe
hp11941a.ant	Typical Antenna Factors for HP 11941A Probe
mag_loop.ant	Typical Antenna Factors for Active Loop Antenna (HP 11966A from 0.010 MHz to 30.0 MHz)
hp11996p.ant	Typical Antenna factors for HP 11996P Broadband Antenna (30 MHz to 1 GHz)

Customer Order Number

Printed in USA

January 1994

** For HP Internal Reference Only **

Manufacturing Part Number

85462-90003



Saving, Recalling, and Outputting Data

This chapter describes how to format a floppy disk, save and recall instrument setups, signal lists, states, traces, display images, limit-line tables, and amplitude-correction factors using both floppy disks and the internal instrument memory.

A floppy disk provides additional memory for saving instrument setup, signal lists, traces, display images, limit-lines tables, and amplitude-correction factors. The data is easily retrievable, (with the exception of display images), without the need for an external controller to transfer data.

The process of saving and recalling data from the floppy disk is similar to saving and recalling data from the internal memory. There are some important differences. For example, data is stored in internal memory as an item; on the floppy disk, data is stored as a DOS file or a logical interchange file (LIF).

Using a Floppy Disk

Formatting the Disk

Use a 3.5 inch double-sided floppy disk. If this is a new floppy disk, it must be formatted before use. The disk can be formatted on a computer or on the EMI receiver, using the following procedure.

Note

Before formatting your floppy disk, make sure that the disk does *not* contain any valuable data by pressing the following keys to catalog the disk.

CONFIG

Disk Config

CATALOG DISK

Existing data on the floppy disk will be displayed if the disk has been formatted. If the disk has not been formatted the following message will be displayed:

Cannot read disk drive. Please verify drive door is closed and that disk is formatted and error free.

Insert the disk with its arrow facing the disk-insertion slot and format the disk by pressing:

CONFIG

Disk Config

FORMAT DOS DISK or **FORMAT LIF DISK**

The message, If you are sure, press key again to purge data appears on the screen. Continue by pressing:

FORMAT DOS DISK or **FORMAT LIF DISK**

Filenames

A filename consists of a:

- prefix (optional)
- register number (required)
- file type descriptor (automatically supplied)

DOS Filenames

A DOS filename is defined as:

prefix + register #.file type descriptor
for example "PREFIX3.SIG"

The filename, excluding the extension, cannot exceed eight characters. The file type descriptor is a three letter extension such as, "SIG" for a signal list.

LIF Filenames

A LIF filename is defined as:

file type descriptor + prefix_register number
for example, "tPREFIX_3"

The filename cannot exceed eight characters. The file type descriptor is a single character preceding the prefix such as, "t", for a trace.

Available Operations

Table 11-1 lists the save and recall operations available using internal memory or the floppy disk.

Refer to Table 11-4 at the end of this section for a summary of functions that can be saved to, and recalled from, internal memory.

Table 11-1. Internal Memory and Floppy Disk Operations

Mass Storage Device	Data Stored As	Stored with a Prefix?	Restriction on Register Number	Types of Data That Can Be Stored ¹	Catalog Functions Available
Internal Memory	Item	No	1 to 8 for states, 0 to MAX REG # for traces and limit lines	States Traces Limit-line tables	CATALOG ALL CATALOG REGISTER CATALOG VARIABLE CATALOG PREFIX DELETE FILE LOAD FILE ²
Floppy Disk	File	Yes	Prefix + register # ≤ 8 character	Setups Lists State Trace Limit-line tables Antenna correction Cable correction Other correction Display images	CATALOG DISK SETUP → DISK LIMITS → DISK LIST → DISK ANTENNA → DISK CABLE → DISK OTHER → DISK DISPLAY → DISK Trace → Disk DELETE FILE LOAD FILE

¹ Specifies types of data that can be stored by using normal front-panel operation.

² When cataloging internal memory, **LOAD FILE** is available for **CATALOG REGISTER** only.

Entering a Prefix

Disk data can be stored and recalled using a prefix. A prefix allows you to give a custom name to your file. The prefix can be from one to seven characters long. The longer the prefix, the shorter the register number must be. The total length of the prefix and register number cannot exceed eight characters. The prefix can be any character; however, the underscore must not be the first character of the prefix.

1. Enter the prefix "TEST", by using the following key sequences:

```

[SAVE]
Change Prefix
STUVWX, T
ABCDEF, E
STUVWX, S
STUVWX, T
    
```

or
CONFIG
 More 1 of 3
 Change Prefix
 STUVWX, T
 ABCDEF, E
 STUVWX, S
 STUVWX, T

Note

If you make a mistake, press **(BK SP)** to erase the incorrect character.

2. To change a prefix, clear the existing prefix and then enter a new prefix. Clear an existing prefix by pressing:

CONFIG
 More 1 of 3
 Change Prefix
 YZ_# Spc Clr
 Clear

or

Use the backspace key to erase the existing prefix.

Saving a Trace

3. Set the receiver to a known state by pressing:

PRESET
INPUT
 VIEW CAL ON OFF ON

4. Enter a screen title by pressing:

DISPLAY
 Change Title
 STUVWX, S
 ABCDEF, A
 STUVWX, V
 ABCDEF, E
 YZ_# Spc Clr
 Space
 STUVWX, T
 ABCDEF, E
 STUVWX, S
 STEVWX, T

5. Enter the prefix "TRACE", by using the following key sequences:

```
(SAVE)
Change Prefix
STUVWX, T
MNOPQR, R
ABCDEF, A
ABCDEF, C
ABCDEF, E
```

Note

If you do not specify a prefix, the trace will be saved with the file name "(register #).TRC". The "TRC" extension means the file contains trace data. For LIF files the trace will be saved with the filename "t_(register #)".

6. Save the trace to disk by pressing:

```
(SAVE)
Save Disk
More 1 of 2
Trace → Disk
TRACE A
```

7. REGISTER # and PREFIX= are displayed on the screen. Use the numeric keypad to enter register number 5 by pressing:

```
5 (ENTER)
```

The message "Saving to:FILENAME" is displayed. The trace data has now been saved to the disk.

Note

If the PROTECT ON OFF is ON you cannot overwrite an existing file. If you try and save data using a filename that already exists on the disk the new data will not be saved. Each filename must be unique. To turn write-protection off, press:

```
(CONFIG)
Disk Config
PROTECT ON OFF OFF
```

Recalling a Trace

Recall the trace by pressing:

RECALL

Recall Disk

More 1 of 2

RECALL TRACE

Use the step keys or knob to highlight "TRACES.TRC",
and then press:

LOAD FILE

The recalled trace data is displayed as trace B.

Reset the display by pressing:

SPAN3 **MHz**

The current trace, trace A, is displayed in yellow. The recalled
trace data, trace B, is displayed in blue.

Note

Recalled trace data includes the instrument state.

The following items can be saved and recalled:

	Save	Recall
Setup	yes	yes
List	yes	yes
Limits	yes	yes
Antenna	yes	yes
Cable	yes	yes
Other	yes	yes
Display	yes	no
Trace	yes	yes

Table 11-2 and Table 11-3 list the operations, their filenames, register ranges and key sequences for saving and recalling data with the EMI receiver and receiver RF section.

Table 11-2. Save Functions Using a Floppy Disk

Operation	Screen Title Available?	File Name DOS [LIF]	Register Range	Key Sequence
save setup	Yes	(current prefix)(register #).ALL [e (current prefix)_(register #)]	Prefix + register # ≤8 characters	SAVE Save Disk SETUP → DISK (register #) (ENTER)
save list	No	(current prefix)(register #).SIG [g (current prefix)_(register #)]	Prefix + register # ≤8 characters	SAVE Save Disk LIST → DISK (register #) (ENTER)
save limits	No	(current prefix)(register #).LIM [l (current prefix)_(register #)]	Prefix + register # ≤8 characters	SAVE Save Disk LIMITS → DISK (register #) (ENTER)
save antenna	No	(current prefix)(register #).ANT [n (current prefix)_(register #)]	Prefix + register # ≤8 characters	SAVE Save Disk ANTENNA → DISK (register #) (ENTER)
save cable	No	(current prefix)(register #).CBL [c (current prefix)_(register #)]	Prefix + register # ≤8 characters	SAVE Save Disk More 1 of 2 CABLE → DISK (register #) (ENTER)
save other	No	(current prefix)(register #).OTH [o (current prefix)_(register #)]	Prefix + register # ≤8 characters	SAVE Save Disk More 1 of 2 OTHER → DISK (register #) (ENTER)
save display image	Yes ¹	(current prefix)(register #).BMP [i (current prefix)_(register #)]	Prefix + register # ≤8 characters	SAVE Save Disk More 1 of 2 DISPLAY → DISK (register #) (ENTER)
save trace	Yes	(current prefix)(register #).TRC [t (current prefix)_(register #)]	Prefix + register # ≤8 characters	SAVE Save Disk More 1 of 2 Trace → Disk TRACE A, TRACE B, TRACE C, or LIMIT LINES (register #) (ENTER)

¹ The screen title is part of the display image, but is an image only. It is not recalled as a title.

Table 11-3. Recall Functions Using a Floppy Disk

Operation	Screen Title Available?	File Name DOS [LIF]	Key Sequence
recall setup	yes	(desired filename).ALL [e (desired filename)]	RECALL Recall Disk RECALL SETUP Highlight desired filename. LOAD FILE
recall list	no	(desired filename).SIG [g (desired filename)]	RECALL Recall Disk RECALL LIST Highlight desired filename. LOAD FILE
recall limits	No	(desired filename).LIM [l (desired filename)]	RECALL Recall Disk RECALL LIMITS Highlight desired filename. LOAD FILE
recall antenna	no	(desired filename).ANT [n (desired filename)]	RECALL Recall Disk RECALL ANTENNA Highlight desired filename. LOAD FILE
recall cable	no	(desired filename).CBL [c (desired filename)]	RECALL Recall Disk More 1 of 2 RECALL CABLE Highlight desired filename. LOAD FILE
recall other	no	(desired filename).OTH [o (desired filename)]	RECALL Recall Disk More 1 of 2 RECALL OTHER Highlight desired filename. LOAD FILE
recall trace	yes	(desired filename).TRC [t (desired filename)]	RECALL Recall Disk More 1 of 2 RECALL TRACE Highlight desired filename. LOAD FILE

Saving and Recalling Data from Internal Memory

This section explains how to save and recall state, trace, and limit line data to and from internal memory. The Save menu can be used to store up to eight states, several traces and limit-line tables in internal memory.

Saving state data saves the instrument settings, but not the trace data. Saving trace data saves the trace data and the state data. Limit-line data are stored in trace registers, but state and trace data are not recalled with the limit-line data. States, traces, and limit-line tables are saved in internal memory even if the instrument is turned off or **PRESET** is pressed.

Refer to Table 11-4 for a summary of saving and recalling data to and from internal memory.

Saving a State

1. Preset the instrument to a known state by pressing:

PRESET

2. Activate the 300 MHz calibrator signal by pressing:

INPUT

VIEW CAL ON OFF (ON)

3. Save this instrument state by pressing:

SAVE

4. Select internal memory as the mass storage device by pressing:

Save Internal

5. Save data in register 5 by pressing:

STATE → INTRNL 5

The message "State saved" is displayed.

Recalling a State

1. Clear the 300 MHz calibrator signal from the display by pressing:

PRESET

2. Recall the 300 MHz calibrator signal from internal memory by pressing:

RECALL

Recall Internal (to select internal)

INTERNAL → STATE 5

The state is recalled and displayed.

Note

Register 9 is a special register which can aid in recovering from inadvertent loss of line power (power failure). Pressing:

RECALL
Recall Internal
INTERNAL → STATE 9 **(ENTER)**

places the instrument in the state that existed just prior to the loss of power. The POWER ON LAST function can be set to do this automatically.

Saving a Trace

Saving trace data is very similar to saving state data. Saving trace data saves both the trace data and the state data.

- 1. Set the receiver to a known state by pressing:

PRESET

- 2. Set up the trace data to be stored and press:

SAVE
Save Internal
Trace → Internal
TRACE A 5 **(ENTER)**

REGISTER # and MAX REG # = are displayed on the screen. The Number after MAX REG # = indicates the maximum register number that can be entered for trace storage in internal memory.

Recalling a Trace

- 1. Recall data from a trace by pressing:

RECALL
Recall Internal
Internal → Trace
TRACE A 5 **(ENTER)**

The recalled trace is placed in the view mode and the instrument state changed to the state that was recalled.

Protecting Data from Being Overwritten

Protect all the state, trace, and limit line data from being overwritten by pressing:

(SAVE)

Save Internal

SAV LOCK ON OFF ON

Table 11-4 summarizes the functions when saving and recalling data to and from internal memory.

Table 11-4.
Summary of Save and Recall Operations, Internal Memory

Operation	Screen Title Available?	Register Range	Key Sequence
save state	No	1 to 8 ¹	(SAVE) Save → Internal STATE → INTRNL (register number) (ENTER)
recall state	No	1 to 8 ¹	(RECALL) Recall → Internal INTERNAL → STATE (register number) (ENTER)
save trace	Yes	0 to MAX REG #	(SAVE) Save → Internal Trace → Intrnl TRACE A, TRACE B, or TRACE C (register number) (ENTER)
recall trace	Yes	0 to MAX REG #	(RECALL) Recall → Internal Internal → Trace TRACE A, TRACE B, or TRACE C (register number) (ENTER)
save limit-line table	Yes ²	0 to MAX REG #	(SAVE) Save → Internal Trace → Intrnl LIMIT LINES (register number) (ENTER)
recall limit-line table	No	0 to MAX REG #	(RECALL) Recall → Internal Internal → Trace LIMIT LINES (register number) (ENTER)

¹ Registers 1 through 8 are available for the user to save a state. State register 0 contains the current state of the instrument, register 9 contains the previous state of the instrument.

² The screen title is displayed when cataloging the trace registers with **CATALOG REGISTER**. The screen title is not recalled with the limit-line tables.

How to Output Data

Data collected in the signal list can be printed or plotted in a report. The report can consist of any of the following elements:

- the user comments (annotations)
- a tabular list of the data
- a plot of the data in the list, on either a linear or logarithmic frequency axis with the limit lines that are currently displayed.
- a listing of the instrument setup parameters, including limit-line and amplitude-correction files

The report may be configured using any, or all, of the elements listed above. The graph can also be saved to a disk.

Note

Only the graph can be sent to a plotter.

Configuring a Printer

The HP 8542E/HP 8546A supports a variety of printers. The receiver must be configured correctly to operate with a specific printer type. Configuration options include:

- printer type
- HP-IB address of the printer
- number of plots per page
- color or monochrome output

The configuration information is used when printing with either the **COPY** key or the OUTPUT REPORTS softkey (located on the **OUTPUT** key menu).

The following procedure configures the receiver to print to an HP ThinkJet printer.

1. Access the printer configuration menu by pressing:

CONFIG

2. Configure the receiver for the type of printer you wish to use. For example, to use an HP ThinkJet printer, press:

Print Config

Printer Type

THINKJET

Config Done

Note

The default printer is the HP DeskJet 550C.

3. Set the HP-IB address of the printer. Enter the last two numbers of the address assigned to the printer. For example, if the printer address is 701, enter 01 by pressing:

PRINTER ADDRESS 01

4. Confirm the entry by pressing:

(ENTER)

Configuring and Generating a Report

Use a list similar to the one created in the “Using the Measure at Marker Function” in Chapter 3 for this procedure.

1. Access the report definition menu by pressing:

OUTPUT

Define Report

2. Verify that all report definitions are set to on (default mode), by selecting the following softkey settings:

ANNOTATN ON OFF ON

LOG ON OFF ON

LIN ON OFF ON

LIST ON OFF ON

SETTINGS ON OFF ON

Note

The ANNOTATN ON OFF function in the Display menu does *not* turn user annotation on and off. It is used to turn on and off onscreen annotation such as the instrument settings, marker box, title line, softkeys, and so forth.

3. To modify the list, press:

Previous Menu

Define List

The display of the data in the list can be tailored to meet your needs. You can:

- Select which of the measured detectors to print to the list.
- Display the differences between a data point and the limit lines, for any of the detectors.
- Elect to indicate which of the list entries have been “marked,” (for more information, see Chapter 4).
- Print the current correction factors used.

4. To modify which detector values are printed to the screen, press:

SHOW DET PK QP AV

The detectors that will be displayed are underlined (defaults are PK,QP). Press the softkey repeatedly to view the detector combinations available.

5. To display the numerical difference between a specific detector reading and limit line 1, press:

SHOW Δ1 PK QP AV

The detectors that will be displayed are underlined. Press the softkey repeatedly to view the detector combinations available.

6. To display the numerical difference between a specific detector reading and limit line 2, press:

SHOW Δ2 PK QP AV

The detectors that are currently detected are underlined. Press the softkey repeatedly to view the detector combinations available.

7. To display the total current correction factor used for the data point displayed, press:

SHOW COR ON OFF ON

8. To display the "mark" in the report, press:

SHOW MRK ON OFF ON

Note

When the maximum number of columns exceeds the maximum number of characters available across a page in portrait orientation, the receiver will print the data in landscape orientation. The Thinkjet printer does not support landscape orientation, and the maximum number of columns that can be printed in portrait mode on this printer is nine.

9. To return to the top level OUTPUT menu,press:

Previous Menu

10. To add user notes to the report, press:

EDIT ANNOTATN

Annotation is entered using the HP 1405A, option ABA external keyboard. The maximum number of ASCII characters allowed in the annotation is 1024. For more information on connecting and using the keyboard, see Chapter 12.

11. To clear any existing annotation, press:

CLEAR ANNOTATN

12. When you finish entering notes, press:

EXIT EDIT

13. Verify the printer is connected to the receiver, then output the report by pressing:

OUTPUT REPORT

14. To halt the operation at any time during the output cycle, press:

ABORT

The receiver will finish any graphs currently in process before aborting the output cycle.

Additional Features

What You'll Learn in This Chapter

This chapter describes additional capabilities of the receiver, including the:

- Signal analyzer emulation
- Demodulator
- Tracking generator

You will also learn:

- How to use, program, and reset the user-definable softkeys
- How to install and use an external keyboard
- How to enter annotation, programming command and screen titles

Signal Analyzer Emulation

The HP 8542E/HP 8546A EMI receiver can be configured to emulate signal analyzer operation. When in signal analysis mode:

- The HP 85420E/HP 85460A RF filter section is bypassed.
- IF bandwidths are coupled to span. (In receiver mode, the IF bandwidth is selected based on center frequency.)
- Limit lines operate differently. Refer to Chapter 8 for more information.

To select signal analyzer mode, press:

MODE
SIGNAL ANALYSIS

Demodulator

The Demodulator control block, located below the display, includes:

ON/OFF	Turns the demodulator on and off.
SELECT	Directly accesses the softkey menus that include AM and FM demodulation, FM gain, dwell time, and squelch level.
VOLUME	Adjusts the audio level of the internal speaker.
PHONEJACK	Provides an audio output for using headphones.

The following list describes each of the menu selections on the Demodulator menu.

DEMOD ON OFF	Turns the demodulator on and off (default is off).
DEMOD AM FM	Selects the demodulator mode (default is AM).
SPEAKER ON OFF	Turns the internal speaker on and off.
SQUELCH	Sets the level of signal required to activate the audio amplifier.
FM GAIN	Changes the sensitivity of the FM discriminator. The sensitivity can be modified to attain sufficient audio output for a specific voltage setting when demodulating narrowband and broadband FM signals.
DWELL TIME	Sets the length of time the demodulator is on at the marker when scanning a frequency range greater than 0 Hz.

Tracking Generator

The tracking generator is a frequency source that automatically tracks the receiver's tuned input frequency. This source is useful when characterizing two-port devices, such as filters, amplifiers, and cables.

To access the tracking generator menus, press:

TRACK GEN

When **SCR POWER ON OFF** is first pressed, the current setting of the output power level is indicated in the active function block, however power is not turned on. To activate the tracking generator, press **SCR POWER ON OFF** a second time or change the output power level using the numeric keypad, step keys, or knob. (A terminator key is required when using the keypad.)

Note

The **PWR SWP ON OFF** and **SRC ATN MAN AUTO** functions operate the same way as the **SCR PWR ON OFF** function.

The following list describes each of the menu selections on the Tracking Generator menu.

- SCR POWER ON OFF** Turns the source power on and off and sets the source power level (default is 97 dB μ V). Use the numeric keys, step keys or knob to set the desired source power level.
- TRACKING PEAK** Aligns the tracking generator output frequency to the tuned frequency of the receiver. The alignment is most critical when using narrow IF bandwidths (≤ 30 kHz). This operation should be performed the first time the tracking generator is used with narrow IF bandwidths each day or when changing the IF bandwidths.
- MAN TRK ADJUST** Enables manual alignment of the tracking generator output frequency to the tuned frequency of the receiver. The alignment is most critical when using narrow IF bandwidths (≤ 30 kHz). Use the numeric keys, step keys or knob to adjust the alignment.
- PWR SWP ON OFF** Varies the output power of the tracking generator over the span (default is off (0 dB), maximum is 15 dB). This feature is useful when measuring the compression of an amplifier. The source power sweep amplitude deviation can be adjusted using the numeric keys, step keys, or knob.
- SRC ATN MAN AUTO** The built-in attenuator is used to optimize the power level of the tracking generator output. In the automatic (default) mode the attenuator is auto-coupled to the output. In the manual mode the power level can be adjusted using the numeric keys, step keys, or knob (maximum is 56 dB).
- More 1 of 2** Accesses the second Tracking Generator menu level.

SCR PWR STP SIZE

Sets the step size value for the step keys (default is 10 dB).

SCR PWR OFFSET

Offsets the value of the displayed source power level (default is 0 dB). This function can be used to account for the gain or loss of a DUT.

ALC INT EXT

The tracking generator is leveled internally (default). When done manually an external signal can be connected to the ALC INPUT.

SWP CPLG SR RECV

Changes sweep time (default is "no delay") in stimulus-response mode to account for the response time of a DUT. This is useful when testing devices such as filters.

More 2 of 2

Accesses the first Tracking Generator menu level.

User-Definable Softkeys

Defaults The top two softkeys on the EMI receiver are user-definable. The two user-definable keys remain the same, regardless of the menu selected. Their default definitions are:

Last Hrd Key Menu Toggles between the lowest level accessed on the last two hard key menus selected.

SPAN Assigns the span function to the user-definable key.

1. To demonstrate the functionality of the LAST HRD KEY MENU key, perform the following procedure. Press:

SETUP

More 1 of 3

Inst Setup

Measure Detector

TEST

More 1 of 3

EDIT LIST

Sort Signals

2. To jump back to the lowest level of the Setup menu you accessed, (Measure Detector), press:

LAST HRD KEY MENU

Pressing the LAST HRD KEY MENU key again jumps back to the lowest level of the Test menu you accessed, (Sort Signals).

Programming

1. To define a user-definable softkey, press:

```
SETUP
More 1 of 3
More 2 of 3
DEFINE USER KEY
```

The message "User Key Define" appears on the display.

2. To define the EDIT LIMIT key as the user defined key, press:

```
SETUP
More 1 of 3
Limit Lines
Limit 1
EDIT LIMIT
USER DEF KEY 1 (the LAST HRD KEY MENU key)
or
USER DEF KEY 2 (the SPAN key)
```

The user-definable softkey you selected is now labeled EDIT LIMIT.

Note

The user-definable softkeys are not affected by:

- pressing instrument preset
 - switching line power on/off
 - recalling a setup from a disk
-

Resetting

To reset a user-definable softkey to the default setting, press:

```
CONFIG
More 1 of 3
Dispose User Mem
DISPOSE USER KEY, DISPOSE USER KEY
```

Note

After pressing **DISPOSE USER KEY** once, the message "If you are sure, press key again to purge data."

will appear. Pressing **DISPOSE USER KEY** a second time deletes the user-defined memory and resets the user-defined softkeys to their default states.

This function resets *both* of the user-defined softkeys.

External Keyboard

Installation To install the external keyboard, (HP 1405A option ABA):

1. Use the LINE switch to turn off power to the receiver.

CAUTION

-
- Turn off the receiver before connecting an external keyboard to the receiver. Failure to do so may result in loss of factory calibration data.
 - Static discharges of greater than 3 kV to metallic portions of the connector housing on the keyboard during operation may cause the instrument to reset.
-

- Plug the keyboard into the EXT KEYBOARD input located on the rear panel of the EMI receiver.
 - Use the LINE switch to turn on power to the EMI receiver.
- The external keyboard is now ready to be used.

Using the Template

The External Keyboard Template (HP part number 85462-80010), displays the functions available when using the external keyboard. The external keyboard has two modes of operation:

- | | |
|-------------------|---|
| Annotation Editor | This mode is used to enter or edit annotation. |
| Keyboard Entry | This mode is used to enter or edit the command line, title line, or prefix. |

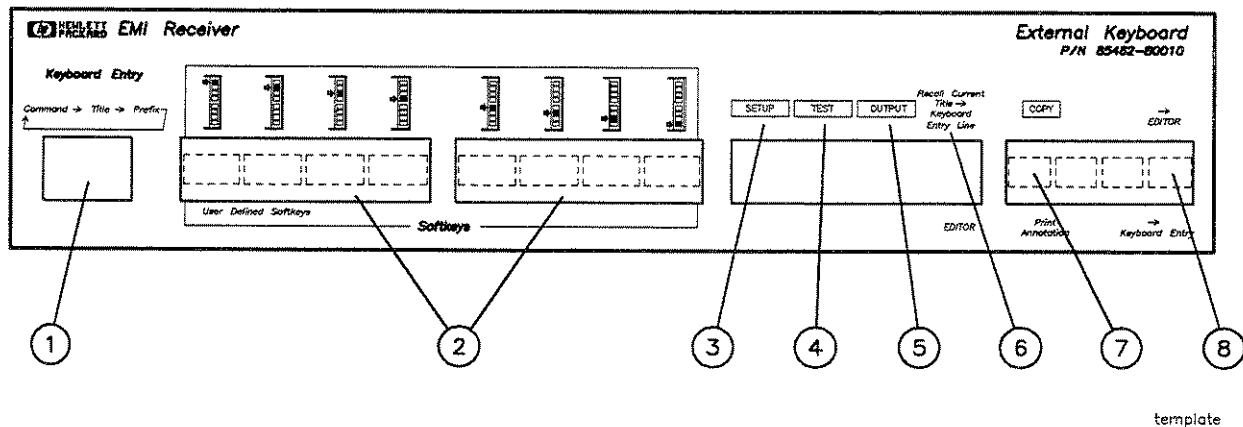

Figure 12-1. External Keyboard Template

This section provides a brief description of the template features. Refer to Figure 12-1.

- 1 EDITOR (**Esc**) is used to select the keyboard entry destination you wish to edit, including the command line, the title, and the prefix.
- 2 The onscreen softkeys can be accessed by pressing the appropriate function key, (**F1**) through (**F8**).
- 3 SETUP, (**F9**), duplicates the front-panel **SETUP** key.
- 4 TEST, (**F10**), duplicates the front-panel **TEST** key.
- 5 OUTPUT, (**F11**), duplicates the front-panel **OUTPUT** key.
- 6 Recall Current Title → Keyboard Entry Line, (**F12**), moves the currently displayed title to the keyboard entry line so it can be edited.
- 7 The function of the **Print Screen** key is determined by the current operating mode. In keyboard entry mode it duplicates the front-panel **COPY** key. In editor mode it prints the annotation.
- 8 The Exit → EDITOR/Exit → Keyboard Entry, (**Pause**), toggles between the two operating modes.

Entering Data Using the External Keyboard

Entering Annotation

The external keyboard can be used to enter explanatory text. Annotation can be:

displayed on the receiver screen to provide additional information printed separately, or as part of a report
stored with the signal list and recalled for future reference

1. Select the Annotation Editor by pressing:

`Exit -> EDITOR`, `(Pause)`, on the external keyboard.

Note

When the Annotation Editor is selected using the external keyboard, annotation is automatically turned on.

Annotation editing can also be turned on from the front panel by pressing:

`OUTPUT`
`EDIT ANNOTATN`

2. To clear any existing annotation:

On the front panel, press: `OUTPUT`

On the external keyboard, press:

`EDIT ANNOTATN`, `(F7)`

`CLEAR ANNOTATN`, `(F3)`

`EXIT EDIT`, `(F8)`

3. Use the external keyboard to enter the following message:

This is an annotation editor. It can be used to record information about the measurement.

Note

The Home, End, Insert, Delete, and arrow keys are available. The backspace, `(←)`, key can also be used.

4. To print the annotation, press:

`Print Annotation`, `(Print Screen)`

For information on saving a signal list and its annotation, see Chapter 4, List-Based Measurements.

5. When you are finished with the annotation, press

`Exit -> Keyboard Entry`, `(Pause)`.

Entering Programming Commands

Remote programming commands can be entered using the external keyboard. See *EMI Receiver Series Programmer's Guide* for a complete list of the remote programming commands.

1. Select the Command function by pressing:

EDITOR, (Esc), until the on-screen message,
"Keyboard Entry -> Command" flashes on the screen.

2. Set the center frequency to 300 MHz and the span to 2 MHz by using the external keyboard to enter:

CF300MZ; Enter
SP2MZ; Enter

Note

When editing the keyboard entry line the down-arrow key, (↓), can be used to recall previously entered lines.

Entering a Screen Title

1. Select the Title function by pressing:

EDITOR, (Esc), until the on-screen message Keyboard Entry → Title flashes on the screen.

2. Use the external keyboard to enter:

This is a title.

When you are finished entering the prefix, press Enter. The new title will move from the Keyboard Entry line to the Title line.

3. To edit an existing Title line move the current title to the Keyboard Entry line by pressing:

Recall Current Title → Keyboard Entry Line, (F12)

4. Use the external keyboard to change the title to read:

This Is a New Title

When you are finished entering the title, press Enter. The title will move from the Keyboard Entry line to the Title line.

Entering a Prefix

1. Select the Prefix function by pressing:

EDITOR, (**Esc**), until the on-screen message Keyboard Entry → Prefix flashes on the screen.

2. Use the external keyboard to enter:

JOY

When you are finished entering the prefix, press **Enter**.

To view the new prefix, press:

SAVE

Change Prefix

The message "Prefix = JOY" is displayed in the active function area of the screen.

3. When you are finished viewing the prefix, press:

More 1 of 2

EDIT DONE

Error Messages

The instrument can generate various messages that appear on its screen during operation to indicate a problem.

There are three types of messages: hardware error messages (H), user-created error messages (U), and informational messages (M).

- Hardware error messages indicate the instrument hardware is probably broken.
- User-created error messages appear when the instrument is used incorrectly. They are usually generated during remote operation (entering programming commands using either a controller or the external keyboard).
- Informational messages provide information indicating the progress of the instrument within a specific procedure.

The messages are listed in alphabetical order on the following pages; each message is defined, and its type is indicated by an (H), (U), or (M).

ϕ LOCK OFF

Indicates slow YTO tuning. This message may appear if the instrument is using default correction factors. If this message appears constantly, perform the self-calibration routine to try to eliminate this message. ϕ LOCK OFF appears briefly during the self-calibration routine, during instrument preset, or when the frequency value is changed; this is normal and does not indicate a problem. (U) and (H)

ADC-2V FAIL

Indicates a hardware failure. (H)

ADC-GND FAIL

Indicates a hardware failure. (H)

ADC-TIME FAIL

Indicates a hardware failure. (H) and (U)

Bad device type in msus

An attempt has been made to read a disk that is neither LIF nor DOS format or a communication failure between the main processor and the floppy disk subsystem. If the disk in use is LIF or DOS format, try turning the instrument off, wait a few seconds, then turn the instrument on again. If the condition persists, contact your HP representative. (U) (H)

Bad mass storage parameter

May be reported if an attempt is made to read a disk that is neither

LIF nor DOS format. Attempt a catalog operation on the disk or try a different disk. (U)

Bad mass storage volume label

May be reported if an attempt is made to read a disk that is neither LIF nor DOS format. Attempt a catalog operation on the disk or try a different disk. (U)

Bad mass storage volume spec

May be generated if the user removes media while it is being accessed or if a read or write operation is attempted on unformatted media. Try the operation again or try the operation on media you are sure has been appropriately formatted.

Cal harmonic > = 5.7 GHz NOT found *For an HP 8546A/HP 85462A only.*

Indicates that the **CAL YTF** routine cannot find a harmonic of the 300 MHz calibration signal. If this happens, perform the **CAL FREQ** and **CAL AMP** routines, and then perform the **CAL YTF** routine again. For the HP 8546A, press **CAL ALL** then perform the **CAL YTF** routine again. (U) and (H)

CAL: MAIN COIL SENSE FAIL

The instrument could not set up span sensitivity of the main coil. If this message appears, press **FREQUENCY**, **CENTER FREQ**, **-37**, **Hz**, **CALIBRATE**, **More 1 of 3**, **More 2 of 3**, **DEFAULT CAL DATA**, and perform the self-calibration routine again. (H)

CAL: NBW 200 Hz notch amp failed

Indicates that the 200 Hz IF bandwidth is not the correct shape for the calibration routine. (H)

CAL: NBW 200 Hz notch failed

Indicates that the 200 Hz IF bandwidth is not the correct shape for the calibration routine. (H)

CAL: NBW 200 Hz width failed

Indicates that the 200 Hz IF bandwidth is not the correct bandwidth for the calibration routine. (H)

CAL: NBW gain failed

Indicates that one of the IF bandwidths is not the correct amplitude for the calibration routine. (H)

CAL: NBW width failed

Indicates that one of the IF bandwidths is not the correct width for the calibration routine. (H)

CAL: PASSCODE NEEDED

Indicates that the function cannot be accessed without the pass code. For the **DEFAULT CAL DATA** function, the pass code is setting the center frequency of the instrument to **-37 Hz**. (M)

CAL: RES BW AMPL FAIL

The relative insertion loss of the IF bandwidth is incorrect. This message also sets **SRQ 110**. (H)

CAL SIGNAL NOT FOUND

Indicates the calibration signal cannot be found. Check that

the instrument input connectors are connected properly. If the calibration signal is connected properly but cannot be found, press **FREQUENCY**, **CENTER FREQ**, **-37**, **Hz**, **CALIBRATE**, **More 1 of 3**, **More 2 of 3**, **DEFAULT CAL DATA**. If the calibration signal still cannot be found, press **FREQUENCY**, **CENTER FREQ**, **-37**, **Hz** and perform the **CAL FREQ** and **CAL AMP** (receiver RF section) or **CAL ALL** (EMI receiver) self-calibration routines. This message also sets SRQ 110. (U) and (H)

CAL: SPAN SENS FAIL

The self-calibration span sensitivity routine failed. This message also sets SRQ 110. (H)

CAL: USING DEFAULT DATA

Indicates that the calibration data is corrupt and the default correction factors are being used. Interruption of the self-calibration routines or an error can cause this problem. (M)

CAL YTF FAILED *For an HP 8546A/HP 85462A only.*

Indicates that the **CAL YTF** routine could not be successfully completed. Perform the self-calibration routines, then perform the **CAL YTF** routine again. (U) and (H)

CAL: ZERO FAIL

The instrument could not set up the tuning sensitivity of the main coil. If this message appears, press **FREQUENCY**, **CENTER FREQ**, **-37**, **Hz**, **CALIBRATE**, **More 1 of 3**, **More 2 of 3**, **DEFAULT CAL DATA**, and perform the self-calibration routines again. (H)

Cannot engage phase lock with current CAL FREQ data

Indicates that the CAL FREQ routine needs to be performed before phase locking can be turned on. (U)

Cannot BYPASS Input 1

An attempt was made to execute the BYPASS command while the signal path is routed through INPUT 1 of the RF filter section. Only INPUT 2 of the RF filter section can be bypassed.

Checkread error

This error may be due to conflicting disk operations invoked from the front-panel keys and the remote I/O port, or it may indicate that the disk is corrupt. After pressing the "HOLD" key, **(ENTER)**, on the front panel, retry the operation. If the operation fails again, check the disk using the catalog function. (U)

COMMAND ERROR: _ _ _

The specified programming command is not recognized by the instrument. (U)

Configuration Error

This error indicates a serious problem in the ability of the instrument to use the floppy disk drive. Try presetting the instrument. If the condition persists, contact your HP representative. (H)

CONF TEST FAIL

Indicates that the confidence test failed. Perform the self-calibration routines, and then perform the confidence test again. This message also sets SRQ 110. (H) and (U)

Directory not empty

Reported if an attempt is made to purge a non-empty directory. Ensure that all files in any directory have been purged or moved before attempting to purge the directory. (U)

Directory overflow

Reported if the disk directory runs out of room. Change the media. (M)

Drive not found or bad address

An attempt has been made to read a disk that is neither LIF nor DOS format or a communications failure between the main processor and the floppy disk subsystem. If the disk in use is LIF or DOS format, try turning the instrument off, wait a few seconds, then turn the instrument on again. If the condition persists, contact your HP representative. (U) (H)

Duplicate file name

Reported if the file system tries to write data to a file that already exists, but did not exist previously. May be due to changing media just before an operation attempts to create a new file. (U)

Duplicate file name, PROTECT is on

Reported if the user attempts to overwrite a previously existing file with PROTECT status set to ON (the default state). Use a different file name, purge the file, or turn off the PROTECT feature. (U)

End of file or buffer found

Reported if an attempt is made to read or write beyond the current file or directory is made. Also reported if an attempt is made to add files to a directory that is already full. Try using a new disk. (U)

End of rec found, random mode

Reported if an attempt is made to read or write beyond the current record being accessed. Try the operation again. (U)

FAIL: _ _ _

An error was discovered during the power-up check. The 4-digit by 10-digit code indicates the type of error. (H)

File name is undefined

May be reported if the user changes media immediately before a read operation is attempted on a file of a specific name. Ensure that the file exists on the disk by using the catalog feature. (U)

File not currently assigned

May be generated if the user removes media while it is being accessed. Try the operation again. (U)

File open on target device

May be due to conflicting file operations invoked simultaneously from the front-panel keys and the remote I/O port. Attempt the operation again. (U)

File type incompatible

Indicates that the selected file is not a display image file. The file name for a display image file is always preceded by an "i." (U)

FREQ UNCAL

The FREQ UNCAL message appearing constantly, indicates a YTO-tuning error. Perform the **CAL FREQ** (receiver RF section) or **CAL ALL** (EMI receiver) routines. (U) and (H)

Function not available in current Mode

Indicates that the function that you have selected can only be used with the instrument mode. You can use the **MODE** key to select the instrument mode. (U)

HFS disc may be corrupt

This error may be due to conflicting disk operations invoked from the front-panel keys and the remote I/O port, or it may indicate that the disk is corrupt. After pressing the "HOLD" key, **ENTER**, on the front panel, retry the operation. If the operation fails again, check the disk using the catalog function. (U)

Improper destination type

Reported if an attempt is made to append data to a file and the file cannot be extended. Try the operation using another disk. (U)

Improper file name

Reported if a file or directory name is specified that in some manner does not conform to file name conventions: too many characters, illegal character in file name, and so on.

Improper file type

Reported in the event that an operation appropriate for a data file is attempted on a directory. Check the contents of the disk using the catalog function. (U)

Improper value or out of range

Indicates an internal error in computing the amount of data to read from the disk or an invalid parameter. This may indicate corrupt media; try a new disk. If the condition persists, contact your HP representative. (H)

Incorrect unit code in msus

An attempt has been made to read a disk that is neither LIF nor DOS format or a communications failure between the main processor and the floppy disk subsystem. If the disk in use is LIF or DOS format, try turning the instrument off, wait a few seconds, then turn the instrument on again. If the condition persists, contact your HP representative. (U) (H)

Incorrect volume code in msvs

An attempt has been made to read a disk that is neither LIF nor DOS format or a communications failure between the main processor and the floppy disk subsystem. If the disk in use is LIF or DOS format, try turning the instrument off, wait a few seconds, then turn the instrument on again. If the condition persists, contact your HP representative. (U) (H)

Insufficient Memory

Indicates a temporary memory overflow condition. Attempt to free

memory that may have been temporarily allocated by performing the following steps:

1. If there is a disk catalog on the display, exit the catalog.
2. Execute the dispose softkeys under **Dispose User Mem** in the **CONFIG** menu. (U)

INTEGER overflow

Indicates a computation error during disk access. This may indicate corrupt media; try a new disk. If the condition persists, contact your HP representative. (H)

Internal error

Indicates a failure of the floppy disk controller or a failure in communications between the main processor and the floppy disk controller. Try turning the instrument off, wait a few seconds, then turn the instrument on again. If the condition persists, contact your HP representative. (H)

INTERNAL LOCKED

The internal trace and state registers of the instrument have been locked. To unlock the trace or state registers, press **SAVE**, **Save Internal**, **SAV LCK ON OFF** so that OFF is underlined. (U)

INVALID AMPCOR: FREQ

For the AMPCOR command, the frequency data must be entered in increasing order. See the description for the AMPCOR programming command for more information. (U)

INVALID ENTER FORMAT

The enter format is not valid. See the appropriate programming command description to determine the correct format. (U)

INVALID <file name> NOT FOUND

Indicates that the specified file could not be loaded into internal memory or purged from memory because the file name cannot be found. (U)

INVALID FILENAME _ _ _

Indicates the specified file name is invalid. A file name is invalid if there is no file name specified, if the first letter of the file name is not alphabetic, or if the specified file type does not match the type of file. See the description SAVRCLW or STOR programming commands for more information. (U)

INVALID FILE: NO ROOM

Indicates that there is insufficient space available on the floppy disk to store the data. (U)

INVALID HP-IB ADRS/OPERATION

An HP-IB operation was aborted due to an incorrect address or invalid operation. Check that there is only one controller (the EMI receiver) connected to the printer or plotter. (U)

INVALID HP-IB OPERATION REN TRUE

The HP-IB operation is not allowed. (This is usually caused by trying to print or plot when a controller is on the interface bus with the instrument.) To use the instrument print or plot functions, you must disconnect any other controllers on the HP-IB. If you are using programming commands to print or plot, you can use an HP

BASIC command instead of disconnecting the controller. See the description for the PRINT command for more information. (U)

INVALID ITEM: _ _ _

Indicates an invalid parameter has been used in a programming command. (U)

INVALID KEYLBL: _ _ _

Indicates that the specified key label contains too many characters. A key label is limited to 8 printable characters per label line. (U)

INVALID KEYNAME: _ _ _

The specified key name is not allowed. (The key name may have conflicted with a instrument programming command.) To avoid this problem, use an underscore as the second character in the key name, or avoid beginning the key name with the following pairs of letters: LB, OA, OL, TA, TB, TR, MA, MF, TS, OT, and DR. (U)

INVALID OUTPUT FORMAT

The output format is not valid. See the appropriate programming command description to determine the correct format. (U)

INVALID RANGE: Stop < Start

Indicates that the first trace element specified for a range of trace elements is larger than ending trace element. When specifying a trace range the starting element must be less than the ending element. For example, TRA[2,300] is legal but TRA[300,2] is not. (U)

INVALID REGISTER NUMBER

The specified trace register number is invalid. (U)

INVALID RS-232 ADRS/OPERATION

An RS-232 operation was aborted due to an invalid operation. (U)

INVALID SAVE REG

Data has not been saved in the specified state or trace register, or the data is corrupt. (U)

INVALID SCRMOVE

Indicates the instrument may have a hardware failure. (H)

INVALID START INDEX

Indicates that the first trace element specified for a range of trace elements is not within the trace range of the specified trace. (U)

INVALID STOP INDEX

Indicates that the ending trace element specified for a range of trace elements is not within the trace range of the specified trace. (U)

INVALID TRACE: _ _ _

The specified trace is invalid. (U)

INVALID VALUE PARAMETER: _ _ _

The specified value parameter is invalid. (U)

INVALID WINDOW TYPE: _ _ _

The specified window is invalid. See the description for the TWINDOW programming command. (U)

LOST SIGNAL

This message indicates that an internal hardware connection problem exists. (H)

LO UNLVL

Indicates that the local oscillator in the EMI receiver distribution amplifier is not functioning properly. (H)

Marker Count Reduce SPAN

Indicates the IF bandwidth to span ratio is too small to use the marker count function. Check the span and IF bandwidth settings. (U)

Marker Count Widen RES BW

Indicates that the current IF bandwidth setting is too narrow to use with the marker counter function. The marker counter function can be in narrow IF bandwidths (bandwidths that are less than 1 kHz) with the following procedure:

1. Place the marker on the desired signal.
2. Increase the IF bandwidth to 1 kHz and verify the marker is on the signal peak.
3. If the marker is on the signal peak, the marker count function can be used in either the 1 kHz IF bandwidth or the original narrow IF bandwidth setting. If the marker is not on the signal peak, it should be moved to the signal peak and the marker counter function should not be used with a IF bandwidth setting of less than 1 kHz. (U)

Mass storage hardware failure

Indicates a failure of the floppy disk controller or a failure in communications between the main processor and the floppy disk controller. Try turning the instrument off, wait a few seconds, then turn the instrument on again. If the condition persists, contact your HP representative. (H)

Mass storage medium overflow

Reported when a disk has no more room available to write data. Try a new disk. (U)

Mass storage system error

Indicates a failure of the floppy disk controller or a failure in communications between the main processor and the floppy disk controller. Try turning the instrument off, wait a few seconds, then turn the instrument on again. If the condition persists, contact your HP representative.

Mass storage volume not present

An attempt has been made to read a disk that is neither LIF nor DOS format or a communications failure between the main processor and the floppy disk subsystem. If the disk in use is LIF or DOS format, try turning the instrument off, wait a few seconds, then turn the instrument on again. If the condition persists, contact your HP representative. (U) (H)

MEAS UNCAL

The measurement is uncalibrated. Check the sweep time, span, and bandwidth settings, or press **AUTO COUPLE**, **AUTO ALL**. (U)

Medium changed or not in drive

Reported if disk is removed during disk access cycle. Try the operation without removing the disk. (U)

Medium uninitialized

Indicates that a file operation has been attempted on an uninitialized disk, or on a disk that is neither LIF nor DOS format. Be sure that any disk on which file operations are attempted is properly formatted. The format softkeys, in the **CONFIG** menu, may be used to format a disk, but any information on the disk will be erased during the formatting process. (U)

No points defined

Indicates the specified limit line or amplitude correction function cannot be performed because no limit line segments or amplitude correction factors have been defined. (U)

Operation failed on some files

Reported if, during a purge operation on a file specifier that contains wildcards, the number of files actually purged does not match the original number of files found that match the file specifier. Check the disk using the catalog function. (U)

Operation not allowed on open file

May be due to conflicting file operations invoked simultaneously from the front-panel keys and the remote I/O port. Attempt the operation again. (U)

OVEN COLD

Indicates that the EMI receiver has been powered up for less than 5 minutes. (The actual temperature of the precision frequency oven is not measured.) (M)

PARAMETER ERROR: - - -

The specified parameter is not recognized by the instrument. See the appropriate programming command description to determine the correct parameters. (U)

PASSCODE NEEDED

Indicates that the function cannot be accessed without the pass code. (U)

Permission denied

Indicates that a file write-operation was attempted on either a read-only file or on a directory. Check the disk using the catalog function and try the operation on an appropriate file again. (U)

Possibly corrupt file

This error may be due to conflicting disk operations invoked from the front-panel keys and the remote I/O port, or it may indicate that the disk is corrupt. After pressing the "HOLD" key, **ENTER**, on the front panel, retry the operation. If the operation fails again, check the disk using the catalog function. (U)

POS-PK FAIL

Indicates the positive-peak detector has failed. (H)

RCVR Limits not allowed in SA mode

This error is encountered when an attempt is made to enable limit-line display, limit-margin display, or limit testing of limits

defined in Receiver mode when the instrument is operating in Signal Analysis mode. To correct the problem, either purge the limits or switch to Receiver mode. (U)

Read data error

This error may be due to conflicting disk operations invoked from the front-panel keys and the remote I/O port, or it may indicate that the disk is corrupt. After pressing the "HOLD" key, (ENTER), on the front panel, retry the operation. If the operation fails again, check the disk using the catalog function. (U)

Record address error

This error may be due to conflicting disk operations invoked from the front-panel keys and the remote I/O port, or it may indicate that the disk is corrupt. After pressing the "HOLD" key, (ENTER), on the front panel, retry the operation. If the operation fails again, check the disk using the catalog function. (U)

Record not found

This error may be due to conflicting disk operations invoked from the front-panel keys and the remote I/O port, or it may indicate that the disk is corrupt. After pressing the "HOLD" key, (ENTER), on the front panel, retry the operation. If the operation fails again, check the disk using the catalog function. (U)

REF UNLOCK

Indicates that the frequency reference is not locked to the external reference input. Check that the 10 MHz REF OUTPUT connector is connected to the EXT REF IN connector, or, when using an external reference, that an external 10 MHz reference source of sufficient amplitude is connected to the EXT REF IN connector. (U) and (H)

Require 1 signal > PEAK EXCURSION above THRESHOLD

Indicates that the N dB PTS routine cannot locate a signal that is high enough to measure. The signal must be greater than the peak excursion above the threshold level to measure. (U)

Require 3 signals > PEAK EXCURSION above THRESHOLD

Indicates that the % AM routine cannot locate three signals that are high enough to measure. The signals must be greater than the peak excursion above the threshold level to measure. (U)

Require 4 signals > PEAK EXCURSION above THRESHOLD

Indicates that the TOI routine cannot locate four signals that are high enough to measure. The signals must be greater than the peak excursion above the threshold level to measure. (U)

Required option not installed

Some instrument functions require that an option be installed in the instrument. See the description for the function in the User's Guide for more information about which option is required. (U)

RF Filter Section Absent

This message is displayed if the bypass command is executed when the RF filter section is not connected to, or is not communicating with, the receiver RF section. (U) and (H)

RFFS Error: COMMAND

The RF filter section has received a command that it does not recognize. Assure that there is no cable connected to the RF filter

section Service Bus interface. If the condition persists, and there is no cable connected to the RF filter section Service Bus interface, contact your HP representative. (U)

RFFS Error: HARDWARE

The RF filter section has experienced a hardware failure. If the condition persists after presetting the instrument or cycling power, contact your HP representative. (H)

RFFS Error: TIMEOUT

Communication failure between the receiver RF section and the RF filter section. Check power to the RF filter section and check that the AUX interface cable is properly connected between both instruments. (U) (H)

RFFS Service Bus Active

This message appears in the active function area of the receiver RF section display when an external controller communicates with the RF filter section via the RF filter section Service Bus interface. (H)

RF PRESEL ERROR *For an HP 8546A/HP 85462A only.*

Indicates that the preselector peak routine cannot be performed. (H)

RF PRESEL TIMEOUT *For an HP 8546A/HP 85462A only.*

Indicates that the preselector peak routine cannot be performed. (H)

SA Limits not allowed in RCVR mode

This error is encountered when an attempt is made to enable limit-line display, limit-margin display, or limit testing of limits defined in Signal Analysis mode when the instrument is operating in Receiver mode. To correct the problem, either delete the limits or switch to Signal Analysis mode. (U)

SAMPLE FAIL

Indicates the sample detector has failed. (H)

SIGNAL CLIPPED

Indicates that the current FFT measurement sweep resulted in a trace that is above the top graticule line on the display. If this happens, the input trace (trace A) has been "clipped," and the FFT data is not valid. (U)

Signal not found

Indicates the PEAK ZOOM routine did not find a valid signal. (U)

Signals do not fit expected % AM pattern

Indicates that the % AM routine cannot perform the percent AM measurement because the onscreen signals do not have the characteristics of a carrier with two sidebands. (U)

Signals do not fit expected TOI pattern

Indicates that the TOI routine cannot perform the third-order intermodulation measurement because the onscreen signals do not have the characteristics of two signals and two distortion products. (U)

SMPLR UNLCK

Indicates that the sampling oscillator circuitry is not functioning

properly. If this message appears, check that the external frequency reference is correctly connected to the EXT REF INPUT. (U) and (H)

SOFTKEY OVFL

Softkey nesting exceeds the maximum number of levels. (U)

SRQ _ _ _

The specified service request is active. (M)

STEP GAIN/ATTN FAIL

Indicates the step gain has failed. (H)

TABLE FULL

Indicates the upper or lower table of limit lines contains the maximum number of entries allowed. Additional entries to the table are ignored. (U)

TG SIGNAL NOT FOUND

Indicates the tracking generator output signal cannot be found. For the receiver RF section, check that the TRACKING GENERATOR OUTPUT is connected to the RF INPUT connector with an appropriate cable. For the EMI receiver, check that the cable between the TRACKING GENERATOR OUTPUT and TRACKING GENERATOR is properly connected. (U)

TG UNLVL

This message can indicate the following: that the source power is set higher or lower than the instrument can provide, that the frequency span extends beyond the specified frequency range of the tracking generator, or that the calibration data for the tracking generator is incorrect. (U)

Too many open files

This error may be due to conflicting disk operations invoked from the front-panel keys and the remote I/O port, or it may indicate that the disk is corrupt. After pressing the "HOLD" key, **(ENTER)**, on the front panel, retry the operation. If the operation fails again, check the disk using the catalog function. (U)

Too many signal with valid N dB points

Indicates the N dB PTS function has located two or more signals that have amplitudes within the specified dB from the signal peak. If this happens, you should decrease the span of the instrument so that only the signal that you want to measure is displayed. (U)

Trace A is not available

Indicates that trace A is in the store-blank mode and cannot be used for limit-line testing. Use **CLEAR WRITE A** or **VIEW A** to change trace A from the store-blank mode to the clear write mode, and then turn on limit-line testing. (U)

Unable to replace file

Reported if an attempt is made to append data to a file and the file cannot be extended. Try the operation using another disk. (U)

USING DEFAULTS self cal needed

Indicates that the current correction factors are the default correction factors and that the self-calibration routines need to be performed. For either an HP 8546A or an HP 85462A, also perform the **CAL YTF** self-calibration routine. (U)

VID-BW FAIL

Indicates the averaging bandwidths have failed. (H)

Wildcard matches > 1 item

An attempt was made to use the wildcard matching character on an operation that requires a specific file name. For example, an attempt to load from a file name that contains a wildcard character. Try the operation using a specific file name. (U)

Wildcards not allowed

An attempt was made to use the wildcard matching character on an operation that requires a specific file name. For example, an attempt to load from a file name that contains a wildcard character. Try the operation using a specific file name. (U)

Write protected

Indicates that a write operation was attempted on a disk that is write protected. Move the write-protect tab on the floppy disk to the unprotected position, reinsert the disk in the disk drive and attempt the operation again. (U)

Nonrecoverable System Errors

Certain situations can create error conditions from which the main processor cannot recover. In the event that the processor detects a nonrecoverable error, the instrument will be initialized, the display will be blanked, and special error messages will be written to the display.

The following is a sample nonrecoverable system error message display.

```
System Error 4, HP 8546A, SN 4
13:18:20 DEC 13, 1993, Rev: 931210
  SR: 0000      PC: 00FFB370      00FF6F1E:      00009300
D0: 00000000    A0: 00FFB238      00FF6F22:      00000000
D1: 00000000    A1: 00FF803E      00FF6F26:      00000000
D2: 00FFB238    A2: 00FF803C      00FF6F2A:      00FF803E
D3: 00FF803E    A3: 00FFB2FE      00FF6F2E:      000031B1
D4: 00008E7D    A4: 00FFB2F4      00FF6F32:      0004065E
D5: 00FF80E8    A5: 00FC6948      00FF6F36:      0004EDE8
D6: 00FFB39A    A6: FFFFFFFE      00FF6F3A:      00FF8000
D7: 00FFB392    A7: 00FF6F1E      00FF6F3E:      00FF88AE
                                00FF6F42:      00FF87E0
                                00FF6F46:      00FFB03C
                                00FF6F4A:      000C9AEA
                                00FF6F4E:      00FF8890
                                00FF6F52:      040800FF
                                00FF6F56:      000900FF
                                00FF6F5A:      B23A0000

WARNING: Config Settings Defaulted
        Press COPY to print error report and
        advise your local HP representative
        Press PRESET to resume operation
```

When a nonrecoverable error message is displayed, the instrument will only respond to the front-panel COPY and PRESET keys. If you have a printer configured and connected to the instrument, and if no remote controller is currently connected to the I/O port through which the printer is connected, you can generate a hardcopy of the diagnostic part of the error message by pressing the front-panel COPY key.

In order to resume instrument operation following a nonrecoverable system error, press the front-panel PRESET key. The instrument will resume operation from its preset state.

Among the conditions which can contribute to the occurrence of a nonrecoverable system error are:

- Hardware failure of the main processor
- Hardware failure of system memory available to the main processor
- Errors in the primary system control program
- Attempted execution of unsupported system commands

Nonrecoverable system errors may occur when attempting to load an improper file type into the machine. For example, loading a file with an incorrect format into a limit line or amplitude correction table may generate this error.

If nonrecoverable system errors occur regularly, contact your HP representative.

Customer Support

Your EMI receiver is built to provide dependable service. It is unlikely that you will experience a problem. However, Hewlett-Packard's worldwide sales and service organization is ready to provide the support you need.

If You Have a Problem

Before calling Hewlett-Packard or returning the EMI receiver for service, please make the checks listed in "Check the Basics." If you still have a problem, please read the warranty printed at the front of this manual. If your EMI receiver is covered by a separate maintenance agreement, please be familiar with its terms.

Hewlett-Packard offers several maintenance plans to service your EMI receiver after warranty expiration. Call your HP Sales and Service Office for full details.

If you want to service the EMI receiver yourself after warranty expiration, contact your HP Sales and Service Office to obtain the most current test and maintenance information.

Calling HP Sales and Service Offices

Sales and service offices are located around the world to provide complete support for your EMI receiver. To obtain servicing information or to order replacement parts, contact the nearest Hewlett-Packard Sales and Service office listed in Table 14-1. In any correspondence or telephone conversations, refer to the EMI receiver by its model number and full serial number. With this information, the HP representative can quickly determine whether your unit is still within its warranty period.

Check the Basics

In general, a problem can be caused by a hardware failure, a software error, or a user error. Often problems may be solved by repeating what was being done when the problem occurred. A few minutes spent in performing these simple checks may eliminate time spent waiting for instrument repair.

If Your EMI Receiver Does Not Turn On

- Check that the EMI receiver is plugged into the proper ac power source.
- Check that the line socket has power.
- Check that the rear-panel voltage selector switches are set correctly.
- Check that the line fuses are good.
- Check that the EMI receiver is turned on.

If the RF Filter Section Does Not Seem to be Working

- Check the ac power to the EMI receiver as described above.
- Verify that the rear-panel auxiliary interface cable is properly connected.
- Verify that the rear-panel sweep ramp and high sweep cables are properly connected.

If the EMI Receiver Cannot Communicate Via HP-IB

- Verify that the proper HP-IB address has been set.
- Verify that there are no equipment address conflicts.
- Check that the other equipment and cables are connected properly and operating correctly.
- Verify that the HP-IB cable is connected to the receiver RF section and not the RF filter section.

Verification of Proper Operation

- Check that the test being performed and the expected results are within the specifications and capabilities of the EMI receiver.
- Check operation by performing the operation verification procedures in Chapter 2 of this manual. Record all results in the operation verification test record.

If the RF filter section Does Not Power Off

- Verify that the service power switch on the RF filter section is set to normal mode.

Error Messages

- Check the EMI receiver display for error messages. Refer to Chapter 13 of this manual.

Additional Support Services

CompuServe CompuServe, the worldwide electronic information utility, provides technical information and support for EMC instrumentation and communication with other EMI users.

With a CompuServe account and a modem-equipped computer, simply type GO HPSYS and select the EMC system section to get information on documentation, application notes, product notes, service notes, software, firmware revision listings, data sheets, and more.

If you are not a member of CompuServe and would like to join, call CompuServe and take advantage of the Free Introductory Membership. The membership includes the following:

- An introductory usage credit to CompuServe
- A private User ID and Password
- A complimentary subscription to CompuServe's monthly computing publication, *CompuServe Magazine*

To take advantage of the CompuServe Free Introductory Membership offer, call one of the telephone numbers below and ask for Representative Number 999.

Country	Toll-Free	Direct
Argentina	—	(+ 54) 01-372-7883
Australia	008-023-158	(+ 61) 2-410-4555
Canada	—	(+ 1) 614-457-8650
Chile	—	(+ 56) 2-696-8807
Germany	0130 86 4643	(+ 49) (+ 89) 66 55 0-222
Hong Kong	—	(+ 852) 867-0102
Israel	—	(+ 972) 3-290466
Japan	0120-22-1200	(+ 81) 3-5471-5806
Korea	080-022-7400	(+ 82) 2-569-5400
New Zealand	0800-441-082	—
South Africa	—	(+ 27) 12-841-2530
Switzerland	155 31 79	—
Taiwan	—	(+ 886) 2-515-7035
United Kingdom	0800 289458	(+ 44) (+ 272) 255111
United States	800-848-8990	(+ 1) 614-457-8650
Venezuela	—	(+ 58) 2-793-2984
Elsewhere	—	(+ 1) 614-457-8650

FAX Support Line

A fax sheet is provided at the end of this chapter as a method in which to directly contact the HP EMC support team in the event of a problem. The fax cover sheet provides EMC support team with information about your company, the product, and a detailed description about the problem.

Note

All items on the fax cover sheet *must* be completed in order to expedite your response. Any incomplete item may delay your response.

Simply copy the fax cover sheet, fill out the requested information, include any additional information sheets, and fax the sheet(s) to HP EMC Support at (707) 577-4200. Depending on the complexity of the problem, you should receive a response back within a few days.

Returning the EMI Receiver for Service

Use the information in this section if it is necessary to return the EMI receiver to Hewlett-Packard.

Note

If you are returning an EMI receiver, you must return both the receiver RF section and RF filter section to the service center for repair and calibration. Also, you must package the units individually to avoid damage.

Package the EMI receiver for shipment

Use the following steps to package the EMI receiver for shipment to Hewlett-Packard for service:

1. Fill in a service tag (available at the end of this chapter) and attach it to the instrument. Please be as specific as possible about the nature of the problem. Send a copy of any or all of the following information:
 - Any error messages that appeared on the EMI receiver display.
 - A completed operation verification test record located at the end of Chapter 2 in this manual.
 - Any other specific data on the performance of the EMI receiver.
-

CAUTION

Damage to the EMI receiver can result from using packaging materials other than those specified. Never use styrene pellets in any shape as packaging materials. They do not adequately cushion the instrument or prevent it from shifting in the carton. Styrene pellets cause equipment damage by generating static electricity and by lodging in the fan.

2. Use the original packaging materials or strong shipping containers that are made of double-walled, corrugated cardboard with 159 kg (350 lb) bursting strength. The cartons must be both large enough and strong enough and allow at least 3 to 4 inches on all sides of the instrument for packing material.
3. Protect the front panel with cardboard.
4. Surround the instrument with at least 3 to 4 inches of packing material, or enough to prevent the instrument from moving in the carton. If packing foam is not available, the best alternative is SD-240 Air Cap™ from Sealed Air Corporation (Commerce, CA 90001). Air Cap looks like a plastic sheet covered with 1-1/4 inch air-filled bubbles. Use the pink Air Cap to reduce static electricity. Wrap the instrument several times in the material to both protect the instrument and prevent it from moving in the carton.
5. Seal the shipping container securely with strong nylon adhesive tape.
6. Mark the shipping container "FRAGILE, HANDLE WITH CARE" to ensure careful handling.
7. Retain copies of all shipping papers.

Table 14-1. Hewlett-Packard Sales and Service Offices

US FIELD OPERATIONS		
<p>Customer Information Hewlett-Packard Company 19320 Pruneridge Avenue Cupertino, CA 95014, USA (800) 752-0900</p>	<p>California, Northern Hewlett-Packard Co. 301 E. Evelyn gw421 South Manhattan Ave. Mountain View, CA 94041 (415) 694-2000</p>	<p>California, Southern Hewlett-Packard Co. Fullerton, CA 92631 (714) 999-6700</p>
<p>Colorado Hewlett-Packard Co. 24 Inverness Place, East Englewood, CO 80112 (303) 649-5000</p>	<p>Georgia Hewlett-Packard Co. 2000 South Park Place Atlanta, GA 30339 (404) 955-1500</p>	<p>Illinois Hewlett-Packard Co. 5201 Tollview Drive Rolling Meadows, IL 60008 (708) 255-9800</p>
<p>New Jersey 120 W. Century Road Paramus, NJ 07653 (201)599-5000</p>	<p>Texas 930 E. Campbell Rd. Richardson, TX 75081 (214) 231-6101</p>	
EUROPEAN FIELD OPERATIONS		
<p>Headquarters Hewlett-Packard S.A. 150, Route du Nant-d'Avril 1217 Meyrin 2/Geneva Switzerland (41 22) 780.8111</p>	<p>France Hewlett-Packard France 1 Avenue Du Canada Zone D'Activite De Courtaboeuf F-91947 Les Ulis Cedex France (33 1) 69 82 60 60</p>	<p>Germany Hewlett-Packard GmbH Berners Strasse 117 6000 Frankfurt 56 West Germany (49 69) 500006-0</p>
<p>Great Britain Hewlett-Packard Ltd Eskdale Road, Winnersh Triangle Wokingham, Berkshire RF11 5DZ England (44 734) 696622</p>		
INTERCON FIELD OPERATIONS		
<p>Headquarters Hewlett-Packard Company 3495 Deer Creek Rd. Palo Alto, California 94304-1316 (415) 857-5027</p>	<p>Australia Hewlett-Packard Australia Ltd. 31-41 Joseph Street Blackburn, Victoria 3130 (61 3) 895-2895</p>	<p>Canada Hewlett-Packard (Canada) Ltd. 17500 South Service Road Trans-Canada Highway Kirkland, Quebec H9J 2X8 Canada (514) 697-4232</p>
<p>China China Hewlett-Packard Co. 38 Bei San Huan X1 Road Shuang Yu Shu Hai Dian District Beijing, China (86 1) 256-6888</p>	<p>Japan Yokogawa-Hewlett-Packard Ltd. 1-27-15 Yabe, Sagamihara Kanagawa 229, Japan (81 427) 59-1311</p>	<p>Singapore Hewlett-Packard Singapore (Pte.) Ltd 1150 Depot Road Singapore 0410 (65) 273-7388</p>
<p>Taiwan Hewlett-Packard Taiwan 8th Floor, H-P Building 337 Fu Hsing North Road Taipei, Taiwan (886 2) 712-0404</p>		



Fax Cover Sheet

To: HP EMC Support FAX Number: (707) 577-4200 Page ___ of ___

Date Transmitted: _____ Time Transmitted: _____

From:

Company: _____

Last Name: _____ First Name: _____

Address: _____

City: _____ State: _____

Country: _____ Postal Code: _____ Mail Stop: _____

Telephone Number (include Country Code): _____

Fax Number (required): _____

Product:

HP 8542E HP 85422E Option(s): _____

HP 8546A HP 85462A Option(s): _____

Serial Number(s): Receiver RF Section RF Filter Section

HP 8542E EMI Receiver: HP 85422E _____ HP 85420E _____

HP 8546A EMI Receiver: HP 85462A _____ HP 85460A _____

Firmware Revision: HP 85422E _____ HP 85420E _____

HP 85462A _____ HP 85460A _____

Is the problem reproducible? Yes No

Detailed Problem Description: (include all setup information and any additional pages)

Index

- 1** 10MHz REF OUTPUT connector, 1-8
- 3** 300 MHz connectors, 1-5
- A** accuracy, 2-2
 - activating
 - amplitude correction, 9-6
 - overview mode, 10-5
 - receiver limit-line testing, 8-8
 - signal analyzer limit-line testing, 8-16
 - windows display mode, 10-2
 - adding
 - data to signal list, 4-3, 5-5
 - ADDRESS switches, 1-9
 - ALC connector, 1-5
 - amplitude and frequency difference, measuring, 7-16
 - amplitude correction
 - activating, 9-6
 - saving and recalling, 9-7
 - tables, creating, 9-1
 - tables, editing, 9-6
 - AMPLITUDE front-panel key, 1-4
 - amplitude modulation, measuring with the FFT function, 7-8
 - analysis control functions, 1-4
 - annotation, screen, 1-10
 - autocal, 2-6
 - autoranging, 3-7
 - AUX IF connector, 1-8
 - AUX INTERFACE connector
 - receiver RF section, 1-8
 - RF filter section, 1-9
 - AUX VIDEO connector, 1-7
 - average bandwidth
 - reducing, 6-26
 - average bandwidth, modifying, 3-4

- B**
 - bandwidth
 - measuring 3 dB and 6 dB, 7-13
 - measuring 99% power, 7-14
 - bandwidths, modifying, 3-4
 - battery, 1-14

- C**
 - CAL FETCH messages, 2-3
 - calibration, 2-3
 - messages, 2-4-5
 - partial, 2-7
 - receiver RF section, 2-9
 - tracking generator, 2-8
 - YIG-tuned filter, 2-8
 - changing the frequency step, 5-5
 - clock, 2-6
 - CNT RES AUTO MAN, 6-8
 - comparing signals, 6-18
 - compliance measurements
 - autoranging, using, 3-7
 - bandwidths, modifying, 3-4
 - configuring a printer, 3-19, 11-12
 - creating a report, 3-19
 - customizing standard configurations, 3-3
 - detector, selection, 3-4
 - dwell time, modifying, 3-6
 - frequencies, modifying, 3-3
 - generating a report, 3-20, 11-13
 - loading amplitude correction factors from disk, 3-11
 - loading configurations from disk, 3-8
 - making, 3-14
 - measure at marker, 3-5
 - preamplifier, controlling, 3-6
 - receiver tuning, 3-14
 - receiver tuning using marker, 3-15
 - reference level, modifying, 3-3
 - setting up, 3-2
 - standard configurations, 3-2
 - using limit lines, 3-8
 - using measure at marker, 3-16
 - CompuServe, 14-3
 - configuring a printer, 3-19, 11-12
 - control functions, 1-4
 - controlling the preamplifier, 3-6
 - COPY front-panel key, 1-4
 - creating
 - amplitude correction tables, 9-1
 - receiver limit lines, 8-2
 - reports, 3-19, 11-12
 - signal analyzer limit lines, 8-11
 - signal lists, 4-2
 - CTRL windows key, 1-4
 - customizing standard configurations, 3-3

- D**
 - damage from excessive signal input, 1-5
 - data
 - controls, 1-6-7
 - entry using external keyboard, 12-9
 - keys, 1-5
 - output, 11-12
 - protection, 11-11
 - deactivate function, 1-7
 - defining a receiver limit margin, 8-7
 - deleting, limit lines in receiver mode, 8-2
 - deleting signals from signal list, 4-7
 - delta marker, 6-18
 - DELTA MEAS softkey, 6-20
 - demodulating an AM or FM signal, 6-36
 - demodulation controls, 1-3
 - demodulator, 12-2
 - detectors, 3-4, 5-3
 - diagnostic measurements, 6-1
 - resolving signals of equal amplitude, 6-2
 - resolving small signals hidden by large signals, 6-5
 - disk
 - catalog, viewing, 8-10
 - drive, 1-3
 - formatting, 1-13, 11-1
 - loading amplitude correction factors from disk, 3-11
 - loading limit lines, 3-9
 - loading user-defined configurations, 3-8
 - tasks, 1-13
 - DISPLAY VIDEO OUT connectors, 1-8
 - distortion, testing, 6-30
 - DOS filenames, 11-2
 - dwelt times, 3-6, 5-3
 - modifying, 3-6
- E**
 - editing
 - amplitude correction tables, 9-6
 - receiver limit lines, 8-2, 8-6
 - signal analyzer limit lines, 8-11, 8-13
 - EMI measurement control, 1-4
 - emulation, signal analyzer, 12-1
 - entering a prefix, 11-3
 - ERROR LED, 1-6
 - error messages, 13-1
 - errors, non recoverable, 13-14
 - excessive signal input, 1-5
 - external keyboard, 12-7
 - EXT KEYBOARD connector, 1-9
 - EXT REF IN connector, 1-8
 - EXT TRIG connector, 1-8

- F**
 - factory-correction constants, 1-8
 - fast Fourier transform function, 7-8
 - measuring sidebands, 7-8
 - fatal errors, 13-14
 - FAX
 - form, 14-7
 - support, 14-4
 - features
 - front panel, 1-3
 - rear panel, 1-7
 - filenames, 11-2
 - formatting a disk, 1-13, 11-1
 - frequency
 - changing the step, 5-5
 - decreasing the span, 6-10
 - modifying, 3-3
 - FREQUENCY front-panel key, 1-4
 - front-panel
 - connectors, 1-5
 - features, 1-3
 - key conventions, 1-12
 - keys, 1-3

- G**
 - GATE connectors, 1-8
 - generating a report, 3-20, 11-13
 - graphing signal lists, 4-11

- H**
 - hardware error messages, 13-1
 - HIGH SWEEP connector
 - receiver RF section, 1-8
 - RF filter section, 1-9
 - HOLD key, 1-7

- I**
 - IF bandwidth
 - function, 6-2
 - modifying, 3-4
 - reducing, 6-25
 - impulse noise
 - measurement, 6-27
 - increase frequency readout resolution, 6-8
 - informational messages, 13-1
 - input attenuation
 - modifying, 3-3
 - reducing, 6-22
 - input attenuator damage, 1-5
 - INPUT connectors, 1-5
 - instrument preset, 1-4
 - interface connector, 1-9
 - intermodulation distortion, measuring, 7-18
 - introduction, EMI receiver, 1-1

- K**
 - keyboard
 - connector, external, 1-9
 - entering data, 12-9
 - external, 12-7
 - template, 12-8
 - key conventions, 1-12
 - knob, 1-6

- L**
 - label, softkey, 1-3
 - LED
 - ERROR, 1-6
 - RF OVERLOAD, 1-5
 - LIF filenames, 11-2
 - limit lines
 - activating signal analyzer, 8-16
 - deleting in receiver mode, 8-2
 - purging in signal analysis mode, 8-12
 - recalling, 8-9
 - receiver, 8-2
 - receiver, activating testing, 8-8
 - receiver, saving, 8-8
 - signal analyzer, 8-11
 - signal analyzer, editing, 8-13
 - signal analyzer, format, 8-15
 - limit margin, receiver, 8-7
 - line
 - power input, 1-9
 - service switch, 1-9
 - switch, 1-3
 - voltage selector, 1-9
 - linearity check, using, 6-30, 6-33
 - linear step, 5-7
 - listening to an AM or FM signal, 6-36
 - loading
 - amplitude correction factors from disk, 3-11
 - user-defined configurations from disk, 3-8
 - logarithmic step, 5-7
 - LO OUTPUT connector, 1-8
 - low-level signals
 - reducing attenuation, 6-22
 - reducing averaging bandwidth, 6-26
 - reducing IF bandwidth, 6-25
 - video averaging, 6-27

- M**
 - marker, 5-4
 - counter, 6-8
 - delta, 6-18
 - functions, 1-4
 - tracking, 6-10
 - marking signals, 4-8
 - MAX HOLD A, 6-16
 - maximum hold, 6-15
 - Measure at Marker, 3-5, 3-16
 - measurement

- control, 1-4
 - restarting, 5-5
 - stopping, 5-5
 - measuring
 - 3 dB and 6 dB bandwidth, 7-13
 - 99% power bandwidth, 7-14
 - amplitude and frequency difference, 7-16
 - low-level signals, 6-22
 - percent AM modulation, 7-15
 - third order products, 7-18
 - menu and softkey overview, 1-12
 - messages
 - CAL FETCH, 2-3
 - calibration, 2-4-5
 - TG UNLVL, 7-7
 - MIN HOLD C, 6-16
 - minimum hold, 6-15
 - MK COUNT ON OFF, 6-8
 - MK TRACK ON OFF, 6-13
 - modifying standard configurations, 3-3
 - moving zone markers, 10-3
- N**
- NEXT windows key, 1-4
 - non recoverable errors, 13-14
 - normalization, 7-5
- O**
- on/off switch, 1-3
 - output, data, 11-12
 - OUTPUT front-panel key, 1-4, 3-2
 - overview mode, activating, 10-5
 - overview of menu and softkeys, 1-12
 - overwrite protection, 11-11
- P**
- package receiver, 14-5
 - packing material, 14-5
 - partial calibration, 2-7
 - peaking signal amplitude, 6-11
 - percent AM modulation
 - measuring, 7-15
 - PHONES connector, 1-3
 - PK-PK MEAS, 7-16
 - power bandwidth, measuring, 7-14
 - power input, receiver RF section, 1-8
 - preamplifier, 3-6
 - prefix
 - editing, 11-4
 - entering, 11-3
 - PRESEL DEFAULT, 6-11
 - preselector peak, 6-11
 - PRESET front-panel key, 1-4
 - printer, configuring, 3-19, 11-12
 - PROBE POWER connector, 1-5
 - problems, how to solve, 14-2
 - procedures, calibration, 2-3

purging, limit lines in signal analysis mode, 8-12

- R**
 - rear-panel
 - battery information label, 1-14
 - connectors, 1-7
 - features, 1-7
 - RECALL front-panel key, 1-4
 - recalling
 - amplitude correction, 9-7
 - limit-line table, 8-9
 - signal lists, 4-10
 - state, internal, 11-9
 - trace, 11-6
 - trace, internal, 11-10
 - receiver, clock, 2-6
 - receiver RF section
 - stand alone calibration, 2-9
 - receiver RF section rear-panel connectors, 1-7, 1-9
 - reference level, modifying, 3-3
 - remeasuring signals, 4-9
 - report
 - configuring, 11-13
 - creating, 11-12
 - generating, 11-13
 - reports
 - configuring, 3-20
 - creating, 3-19
 - generating, 3-20
 - resolving signals, 6-5
 - RF
 - INPUT connector, 1-5
 - OUT connector, 1-5
 - OVERLOAD LED, 1-5
 - RPG knob, 1-6
- S**
 - sales and service offices, 14-6
 - SAVE front-panel key, 1-4
 - saving
 - amplitude correction, 9-7
 - receiver limit-line table, 8-8
 - signal lists, 4-10
 - state, internal, 11-9
 - trace, 11-4
 - trace, internal, 11-10
 - screen annotation, 1-10
 - SELECT demodulation key, 1-3
 - selecting detectors, 3-4, 5-3
 - self-calibration, 2-3
 - partial, 2-7
 - receiver RF section, 2-9
 - requirements, 2-2
 - tracking generator, 2-8
 - YIG-tuned filter, 2-8
 - sensitivity, receiver, 6-22

- service bus
 - address, 1-9
 - connector, 1-9
- service, returning for, 14-5
- SETUP front-panel key, 1-4, 3-2
- sidebands, measuring, 7-8
- signal
 - comparison, 6-18
 - difference on and off screen, 6-19
 - differences, 6-18
 - separation, 6-5
 - tracking, 6-10
- signal analyzer
 - limit line format , 8-15
 - limit lines, activating, 8-16
 - limit lines, creating, 8-11
 - limit lines, editing, 8-13
- signal analyzer emulation, 12-1
- signal list
 - adding signals, 4-3
 - creating, 4-2
 - deleting signals, 4-7
 - graphing, 4-11
 - marking, 4-8
 - remeasuring, 4-9
 - saving and recalling, 4-10
 - sorting, 4-6
 - table, 5-5
 - viewing, 4-5
- small signals, measuring in presence of large ambient, 6-30
- softkey
 - conventions, 1-12
 - descriptions, 1-4
 - label, 1-3
 - user-definable, 12-5
- sorting signal lists, 4-6
- SPAN front-panel key, 1-4
- SPAN ZOOM, 6-13
- SRC PWR ON OFF softkey, 7-3
- standard configurations, 3-2
 - customizing, 3-3
- start and stop frequency, modifying, 3-3
- state functions, 1-4
- step
 - frequency, 5-5
 - linear, 5-7
 - logarithmic, 5-7
- step keys, 1-7
- stepped measurements, 5-1
- stimulus-response measurements, 7-2
- stimulus-response mode, 7-4
- support, FAX, 14-4
- SWEEP RAMP connector
 - receiver RF section, 1-8
 - RF filter section, 1-9

sweep time, 6-2

- T** tables
 amplitude correction, activating, 9-6
 amplitude correction, creating, 9-1
 amplitude correction, editing, 9-6
 amplitude correction, saving and recalling, 9-7
 limit line, format of signal analyzer, 8-15
 limit line, recalling, 8-9
 receiver limit line, saving, 8-8
TEST front-panel key, 1-4, 3-2
TG UNLVL message, 7-7
third order measurements, 7-18
TRACK GEN front-panel key, 1-4, 7-3
tracking generator, 12-2
 calibration, 2-8
 connector, 1-5
 normalization, 7-5
 stimulus-response, 7-2
 unleveled condition, 7-7
tracking unstable signals, 6-13
troubleshooting, 14-2
- U** unleveled condition, tracking generator, 7-7
user-created error messages, 13-1
user-definable softkeys, 12-5
- V** video averaging, 6-27
viewing
 disk catalog, 8-10
 receiver limit lines, 8-2
 signal analyzer limit lines, 8-11
 signal list, 4-5
VOLTAGE SELECTOR, 1-8
VOLUME control, 1-3
- W** warm-up time, 2-2
windows display mode, 1-10
 activating, 3-12, 10-2
 activating overview mode, 10-5
 moving zone markers, 10-3
 turning off, 10-6
windows keys, 1-4
write protection, 11-11
- Y** YIG-tuned filter self-calibration, 2-8
- Z** ZERO SPAN, 6-11
zone markers, 10-3
ZOOM windows key, 1-4

